

GRUPO 
ADV®

ADVERSIA®

DCB
DACOBEL

 **EUROSAVOY**®

*“Unidos por
el trabajo”*



“ Unidos por el Trabajo ”

Nos complace anunciar que hemos creado un **nuevo logo que unificará todas nuestras marcas bajo una sola identidad visual**. Este cambio refleja nuestro compromiso con la innovación y la coherencia en todos nuestros productos y servicios.

Nuestro nuevo logo simboliza la unión de nuestras diversas marcas, representando nuestra misión de ofrecer calidad y excelencia en cada aspecto de nuestro negocio. Creemos que esta nueva imagen fortalecerá nuestra presencia en el mercado y facilitará el reconocimiento de nuestra marca.

Agradecemos su continuo apoyo y esperamos que este nuevo logo sea un **símbolo de nuestra dedicación a servirles mejor cada día**.

¡Grupo ADV, eres TÚ!





Unidos por la
Excelencia

Nuestras Líneas



Línea de diseño exclusiva y con limitación de stock para analizar tendencias de mercado. Crisol de ideas e inspiración para nuevas prendas y proyectos corporativos.



Nuestros productos más vendidos y con el precio más competitivo.



Artículos confeccionados con los tejidos, componentes y fornituras más exclusivos del sector.

ADVERSIA®

DCB®
DACOBEL

EUROSAVOY®

Los tejidos del Futuro ya son Presente

NanoTec Technology

Con esta **tecnología revolucionaria** hemos creado una composición química a nivel molecular que se le aplica al tejido y que le da unas **propiedades hidrófugas**. Con ello conseguimos que las prendas tengan una **durabilidad** mas alta sin perder sus prestaciones.



Hidrofugado

NanuTec "El Camaleón de los Tejidos"

Desde hace años hemos utilizado esta hilatura propia para conseguir una segunda piel con nuestros productos térmicos que hacen que seamos **número uno en el sector**. Pioneros en testar estas prendas en laboratorio con notas sensacionales.

Hay muchas prendas térmicas, pero sólo un **NANUTEC**.



Un **tejido inteligente** que destaca por tener una gran adaptabilidad a la temperatura externa, ya que cuando hace frío se cierra para que este no pase y así mantener el calor.

SOLITEC INDUSTRY polycotton económico



Durabilidad del color
Mercerizado
Sanforizado



Resistente al pilling
Tejido elástico
Plancha fácil

SOLITEC STRETCH polycotton elástico



Durabilidad del color
Colores limpios
Repelente a líquidos



Resistente al pilling
Tejido elástico
Plancha fácil

SOLITEC polycotton



Durabilidad del color
Colores limpios
Resistente al pilling

SOLITEC PLUS+ polycotton anti-pilling

Las innovadoras fibras largas de algodón peinado Solitec Plus + le aportan mayor resistencia al pilling.

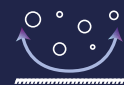

THERMOLITE

- Ayuda a mantenerse fresco.
- Seco y confortable.
- Mantiene la temperatura corporal.
- Tejido transpirable
- De secado rápido
- Flexible y ligero
- Se puede lavar a máquina

COOLMAX

- Ayuda a mantenerse fresco.
- Seco y confortable.
- Tejido transpirable.
- De secado rápido.
- Flexible y ligero.
- Se puede lavar a máquina.

Comodidad en cada fibra

HidroFlex Microfibra

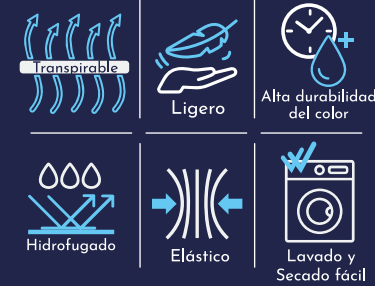

Transpirable
Ligero
Alta durabilidad del color
Hidrofugado
Elástico
Lavado y Secado fácil

GRATIO Microfibra



Transpirable
Ligero
Alta durabilidad del color
Hidrofugado
Lavado y Secado fácil

ETEREA 63% poliéster 34% algodón 3% Spandex Elastic

Elasticidad
Suavidad
Ligereza

ETEREA 65% poliéster 35% algodón

Fino acanalado horizontal
Suavidad
Ligereza

SuitFlex

"El mejor tejido para tu día a día"

Elástico, fresco, cómodo, ligero, agradable al tacto y elegante.

LYCRA ONLY BY DUPONT

- Se estira de cuatro a siete veces para luego volver a su tamaño inicial.
- Apenas se afloja el estiramiento, vuelve instantáneamente a la longitud inicial.
- Mantiene su elasticidad en el tiempo.
- Es completamente invisible y no modifica el aspecto exterior del tejido.
- Las prendas con fibra LYCRA® no requieren cuidados especiales: easycare.

BIONIC FINISH

- Componente hidrófugo aplicado.
- Repelente a la suciedad.
- Mantiene nuevos los colores y el tejido a largo plazo.
- Deja los tejidos secarse más rápido.
- Hace que el cuidado del tejido sea fácil.
- Resistente al agua.
- Resistente al clima.



ÍNDICE

¿has visto ya los escaparates?

Los escaparates se encuentran al principio de cada categoría, con estos resúmenes visuales, podrás encontrar de una manera sencilla y cómoda la prenda que estás buscando.

1.- AMERICANAS Y CHALECOS.....	8-33	8.-DELANTALES Y CASULLAS.....	178-225
Americanas.....	10-29	Delantales.....	182-220
Chalecos.....	30-33	Casullas.....	221-223
2.-PANTALONES.....	34-97	9.-GORROS Y COFIAS.....	226-235
Pantalones Corporativos, HoReCa, Sanitarios y Limpieza.....	38-89	Gorros.....	228-233
Pantalones Industria.....	90-97	Cofias.....	234-235
3.-BERMUDAS, FALDAS Y VESTIDOS.....	98-109	10.-CASACAS.....	236-259
Bermudas.....	99-101	11.-BATAS Y PIJAMAS.....	260-269
Faldas.....	102-107	Batas.....	262-268
Vestidos.....	108-109	Pijamas.....	269
4.-COMPLEMENTOS.....	110-112	12.-INDUSTRIA ALIMENTARIA.....	270-279
5.-CAMISAS Y BLUSAS.....	113-144	Casacas.....	272-279
Camisas y Blusas Cuello Mao.....	116-127	Pantalones.....	274-275
Camisas y Blusas Cuello Camisero.....	128-139	Batas.....	276-277
Blusas Especiales.....	140-144	Balaclavas.....	278-279
6.-PRENDAS DE PUNTO.....	145-157	Manguitos.....	278-279
Jerseys.....	147-152	13.-ALTA VISIBILIDAD.....	280-281
Chaquetas.....	153-155	14.-ROPA TÉRMICA.....	282-287
Chalecos.....	156-157	15.-CALCETINES.....	288-309
7.-CHAQUETAS DE COCINA.....	158-177	16.-CHIC LINE "Bajo Pedido".....	310-319
Chaquetas de cocina Manga Larga.....	160-171		
Chaquetas de cocina Manga Corta.....	172-177		

Americanas y Chalecos



ESCAPARATE Americanas y Chalecos

Chalecos

Pág 31

Suitflex 641M2023 Suitflex 6412023

100% Poliéster

Pág 71

Basic+ 603MT6180 Martita 603T6180

100% Poliéster Stretch

Pág 71

630M2013 6302013

65% Poliéster, 35% Viscosa

Pág 24

Protel 10002007 Protel 20002007

55% Poliéster, 43% Lana, 2% Lycra

Pág 26

Satén Elástico 10082501 Satén Elástico 20622501

97% Algodón, 3% Elastano

Pág 28

Boutique 20712025

95% Poliéster, 5% Elastano

Pág 29

Taste 20742024

97% Nylon, 3% Spandex

Americanas

Pág 10

Suitflex 10152023 Suitflex 20752023

100% Poliéster

Pág 12

Basic+ 223A6180 Basic+ 20046180

100% Poliéster Stretch

Pág 13

Basic+ 20016180

100% Poliéster Stretch

Pág 13

Basic+ 20416180

100% Poliéster Stretch

Pág 14

Micropol 10092010 Micropol 20632010

100% Poliéster Microfibra

Pág 16

Micropol 10042010 Micropol 20042010

100% Poliéster Microfibra

Pág 17

Forte 223A6182 Forte 20046182

100% Poliéster Sarguita

Pág 18

Cómodo 10066173

94% Poliéster, 6% Spandex

Pág 19

Cómodo 20226173

94% Poliéster, 6% Spandex

Pág 19

Cómodo 20316173

94% Poliéster, 6% Spandex

Pág 20

Plácido 10052011 Plácido 20222011

77% Poliéster, 20% Viscosa, 3% Elastano

Pág 21

Legend 223A6170 Legend 20046170

45% Lana, 55% Poliéster

Pág 22

Flexus 223A2009 Flexus 20042009

55% Poliéster, 43% Lana, 2% Lycra

Pág 25

Protel 20042007

55% Poliéster, 43% Lana, 2% Lycra



Americana
Suitflex
Elástica
Sin forro interior
Señora

Mod. 20752023
Serie: 2023
Tejido: Suitflex

Tallas:
De la 34 a 54

Composición:
100% Poliéster
180 gr/m2

Colores:

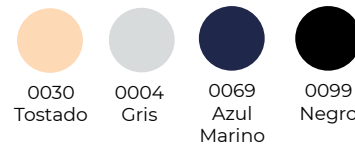

Americana
Suitflex
Elástica
Sin forro interior
Caballero

Mod. 10152023
Serie: 2023
Tejido: Suitflex

Tallas:
De la 44 a 64

Composición:
100% Poliéster
180 gr/m2

Colores:

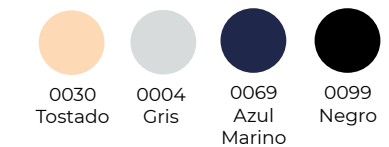



Americana Dos Botones

Poliéster-Stretch
Caballero

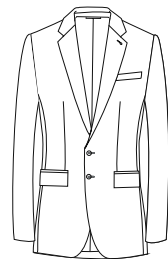

Mod. 223A6180
Serie 6180
Tejido Basic+

Composición:
100% Poliéster, stretch
170 gr/m²

- ▶ Dos botones
- ▶ Dos aberturas

Tallas: De la 44 a la 68

Colores disponibles:

- 0019 Gris
- 0069 Marino
- 0099 Negro

Americana Dos Botones

Poliéster-Stretch
Señora

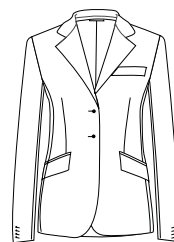

Mod. 20046180
Serie 6180
Tejido Basic+

Composición:
100% Poliéster, stretch
170 gr/m²

- ▶ Dos botones
- ▶ Una abertura

Tallas: De la 34 a la 58

Colores disponibles:

- 0069 Marino
- 0099 Negro

Americana Tres Botones

Poliéster-Stretch
Señora



Mod. 20016180
Serie 6180
Tejido Basic+

Composición:
100% Poliéster, stretch
170 gr/m²

- ▶ Tres botones
- ▶ Una abertura

Tallas: De la 34 a la 58

Colores disponibles:

- 0019 Gris
- 0069 Marino
- 0099 Negro

Americana Dos Botones

Cuello Chimenea
Poliéster-Stretch
Señora

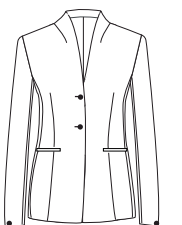

Mod. 20416180
Serie 6180
Tejido Basic+

Composición:
100% Poliéster, stretch
170 gr/m²

- ▶ Dos botones

Tallas: De la 34 a la 54

Colores disponibles:

- 0069 Marino
- 0099 Negro



Americana Sin Forro

Semi-entallada MICROFIBRA

Caballero

Mod. 10092010
Serie 2010
Tejido Micropol

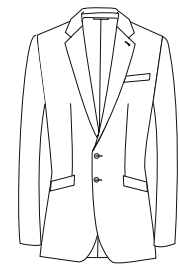

Composición:
100% Poliéster
Microfibra
125 gr/m²

- ▶ Sin Forro
- ▶ Dos botones
- ▶ Dos aberturas
- ▶ Semi-entallada

Tallas: De la 42 a la 60

Colores disponibles:

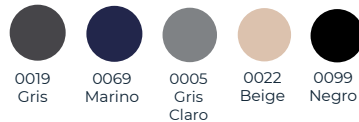

Americana Sin Forro

Semi-entallada MICROFIBRA

Señora

Mod. 20632010
Serie 2010
Tejido Micropol



Composición:
100% Poliéster
Microfibra
125 gr/m²

- ▶ Dos botones
- ▶ Una abertura
- ▶ Sin forro

Tallas: De la 34 a la 54

Colores disponibles:

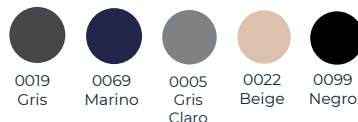



Americana Dos Botones

Microfibra
Caballero



Mod. 10042010
Serie 2010
Tejido Micropol

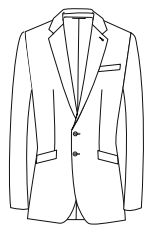

Composición:
100% Poliéster
Microfibra
125 gr/m²

- Dos botones
- Dos aberturas
- Semi-entallada

Tallas: De la 44 a la 68

Colores disponibles:

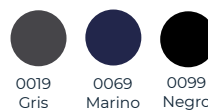

Americana Dos Botones

Microfibra
Señora

Mod. 20042010
Serie 2010
Tejido Micropol



Composición:
100% Poliéster
Microfibra
125 gr/m²

- Dos botones
- Una abertura

Tallas: De la 34 a la 58

Colores disponibles:

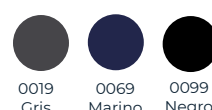

Americana Dos Botones

Poliéster-Sarga
Caballero



Mod. 223A6182
Serie 6182
Tejido Forte

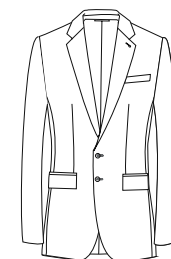

Composición:
100% Poliéster
Sarguita
219 gr/m²

- Dos botones
- Dos aberturas

Tallas: De la 44 a la 68

Colores disponibles:

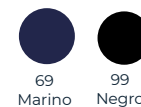

Americana Dos Botones

Poliéster-Sarga
Señora

Mod. 20046182
Serie 6182
Tejido Forte

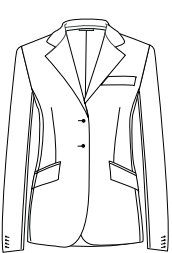

Composición:
100% Poliéster
Sarguita
219 gr/m²

- Dos botones
- Una abertura

Tallas: De la 34 a la 58

Colores disponibles:

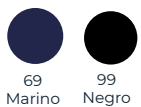

Americana Dos Botones

Poliéster-Elástico
Caballero



- ▶ Dos botones
- ▶ Una abertura trasera
- ▶ Solapa 5 cm
- ▶ Semi-entallada

Mod. 10066173

Serie: 6173

Tejido: Cómodo

Tallas:

De la 44 a la 58

Composición:

94% Poliéster
6% Spandex
215 gr/m²

Colores:



0099
Negro



0069
Azul
Marino



Americana Dos Botones

Poliéster-Elástico
Señora



Mod. 20226173
Serie 6173
Tejido Cómodo

Composición:
94% Poliéster
6% Spandex
215 gr/m²

- ▶ Dos botones
- ▶ Solapa recta
- ▶ Abertura trasera

Tallas: De la 34 a la 58

Colores disponibles:



69 Marino
99 Negro



Americana Un Botón

Solapa Pico
Poliéster-Elástico
Señora

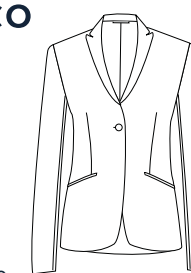

Mod. 20316173
Serie 6173
Tejido Cómodo

Composición:
94% Poliéster
6% Spandex
215 gr/m²

- ▶ Un botón
- ▶ Solapa pico
- ▶ Abertura trasera

Tallas: De la 34 a la 58

Colores disponibles:



69 Marino
99 Negro



Elástico

PLÁCIDO

Composición:

- Poliéster 77%
- Viscosa 20%
- Elastómero 3%



Americana Dos Botones

Viscosa Elástica
Caballero

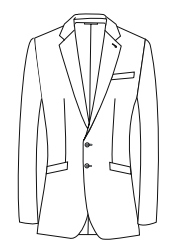

Mod. 10052011
Serie 2011
Tejido Plácido

Composición:
77% Poliéster
20% Viscosa
3% Elastómero
185 gr/m²

- ▶ Dos botones
- ▶ Dos aberturas
- ▶ Semi-entallada

Tallas: De la 42 a la 68

Colores disponibles:

- 19 Gris
- 69 Marino
- 99 Negro

Americana Dos Botones

Viscosa Elástica
Señora

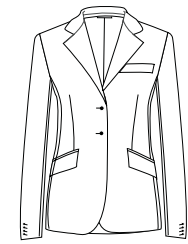

Mod. 20222011
Serie 2011
Tejido Plácido

Composición:
77% Poliéster
20% Viscosa
3% Elastómero
185 gr/m²

- ▶ Dos botones bajos
- ▶ Una abertura

Tallas: De la 34 a la 58

Colores disponibles:

- 19 Gris
- 69 Marino
- 99 Negro



Americana Dos Botones

Sarga Lana
Caballero

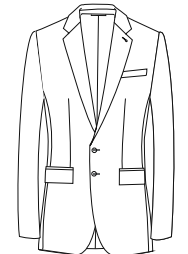

Mod. 223A6170
Serie 6170
Tejido Legend

Composición:
45% Lana
55% Poliéster
190 gr/m²

- ▶ Dos botones
- ▶ Dos aberturas

Tallas: De la 44 a la 68

Colores disponibles:

- 19 Gris
- 69 Marino
- 99 Negro

Americana Dos Botones

Sarga Lana
Señora

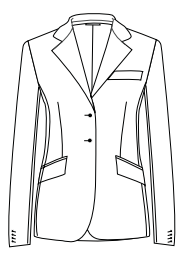

Mod. 20046170
Serie 6170
Tejido Legend

Composición:
45% Lana
55% Poliéster
190 gr/m²

- ▶ Dos botones
- ▶ Una abertura

Tallas: De la 34 a la 58

Colores disponibles:

- 19 Gris
- 69 Marino
- 99 Negro



Americana Dos Botones

Bengalina-Elástica

Caballero

Mod. 223A2009
Serie 2009
Tejido Flexus

Composición:
43% Lana
55% Poliéster
2% Lycra®
205 gr/m²

- ▶ Dos botones
- ▶ Dos aberturas

Tallas: De la 44 a la 68

Colores disponibles:

- 15 Gris Medio
- 69 Marino
- 05 Gris Claro
- 22 Beige
- 99 Negro

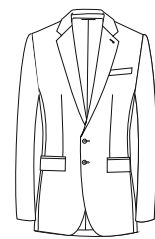

Americana Dos Botones

Bengalina-Elástica

Señora

Mod. 20042009
Serie 2009
Tejido Flexus

Composición:
43% Lana
55% Poliéster
2% Lycra®
205 gr/m²

- ▶ Dos botones
- ▶ Una abertura

Tallas: De la 34 a la 58

Colores disponibles:

- 15 Gris Medio
- 69 Marino
- 05 Gris Claro
- 22 Beige
- 99 Negro





Americana Dos Botones

Lana Antimanchas
Caballero



Mod. 10002007
Serie 2007
Tejido Protel

Composición:
55% Poliéster
43% Lana
2% Lycra®
205 gr/m²

- ▶ Dos botones
- ▶ Dos aberturas

Tallas: De la 44 a la 68

Colores disponibles:

- 19 Gris
- 69 Marino
- 99 Negro



Americana Tres Botones

Lana Antimanchas
Señora

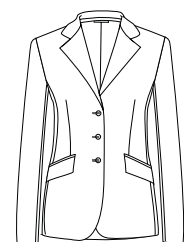

Mod. 20002007
Serie 2007
Tejido Protel

Composición:
55% Poliéster
43% Lana
2% Lycra®
205 gr/m²

- ▶ Tres botones
- ▶ Una abertura

Tallas: De la 34 a la 58

Colores disponibles:

- 19 Gris
- 69 Marino
- 99 Negro



AMERICANA Dos Botones

Lana Antimanchas
Caballero

Mod. 20042007
Serie 2007
Tejido Protel



- ▶ Dos botones
- ▶ Una abertura

Composición:
55% Poliéste
43% Lana
2% Lycra®
205 gr/m²

Tallas: De la 34 a la 58

Colores disponibles:

- 69 Marino
- 19 Gris Marengo
- 99 Negro

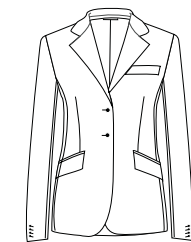



Americana Sin Forro

Algodón-Elástico

Caballero

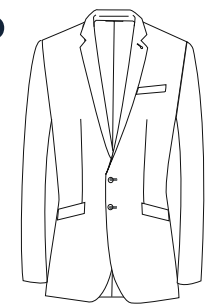

Mod. 10082501
Serie 2501
Tejido Satén elástico

- Composición:**
97% Algodón
3% Elastano
200 gr/m²
- ▶ Sin forro
 - ▶ Dos botones
 - ▶ Dos aberturas traseras
 - ▶ Solapa 5 cm

Tallas: De la 42 a la 60

- Colores disponibles:
- 0069 Marino
 - 0022 Beige
 - 0099 Negro

Americana Sin Forro

Algodón-Elástico

Señora



Mod. 20622501
Serie 2501
Tejido Satén elástico

- Composición:**
97% Algodón
3% Elastano
200 gr/m²
- ▶ Sin forro
 - ▶ Dos botones
 - ▶ Solapa recta
 - ▶ Abertura trasera

Tallas: De la 34 a la 54

- Colores disponibles:
- 0069 Marino
 - 0022 Beige
 - 0099 Negro



Chaqueta Tipo Chanel

4 Bolsillos

Botones Dorados

Señora



Mod. 20712025

Serie: 2025

Tejido: Boutique

Tallas:

De la 36 a 50

Composición:

95% Poliéster
5% Elastano
200 gr/m2

Colores:



0099
Negro

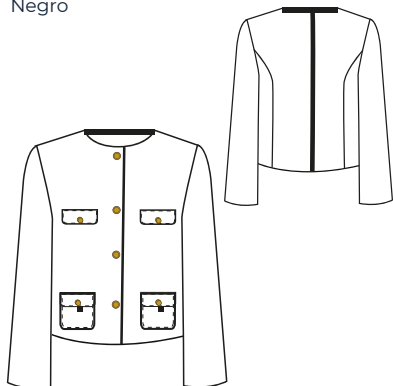

Americana con recogemanga

Señora



Mod. 20742024

Serie: 2024

Tejido: Taste

Tallas:

De la XS a 4XL

Composición:

97% Poliéster
3% Spandex
200 gr/m2

Colores:



0099
Negro



0069
Azul
Marino

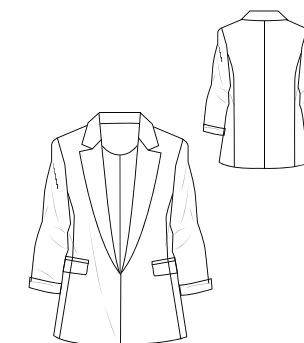



Chaleco Suitflex Cruzado

Doble fila de botones,
Botones funcionales y decorativos
Espalda con forro a tono,
hebilla ajustadora
Solapa recta

Señora

Mod. 641M2023

Serie: 2023

Tejido: Suitflex

Tallas:

De la 36 a 52

Caballero

Mod. 6412023

Serie: 2023

Tejido: Suitflex

Tallas:

De la 44 a 60

Composición:

100% Poliéster
180 gr/m2

Colores:

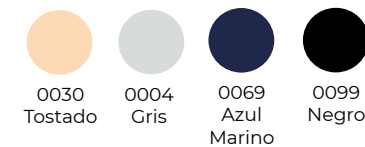

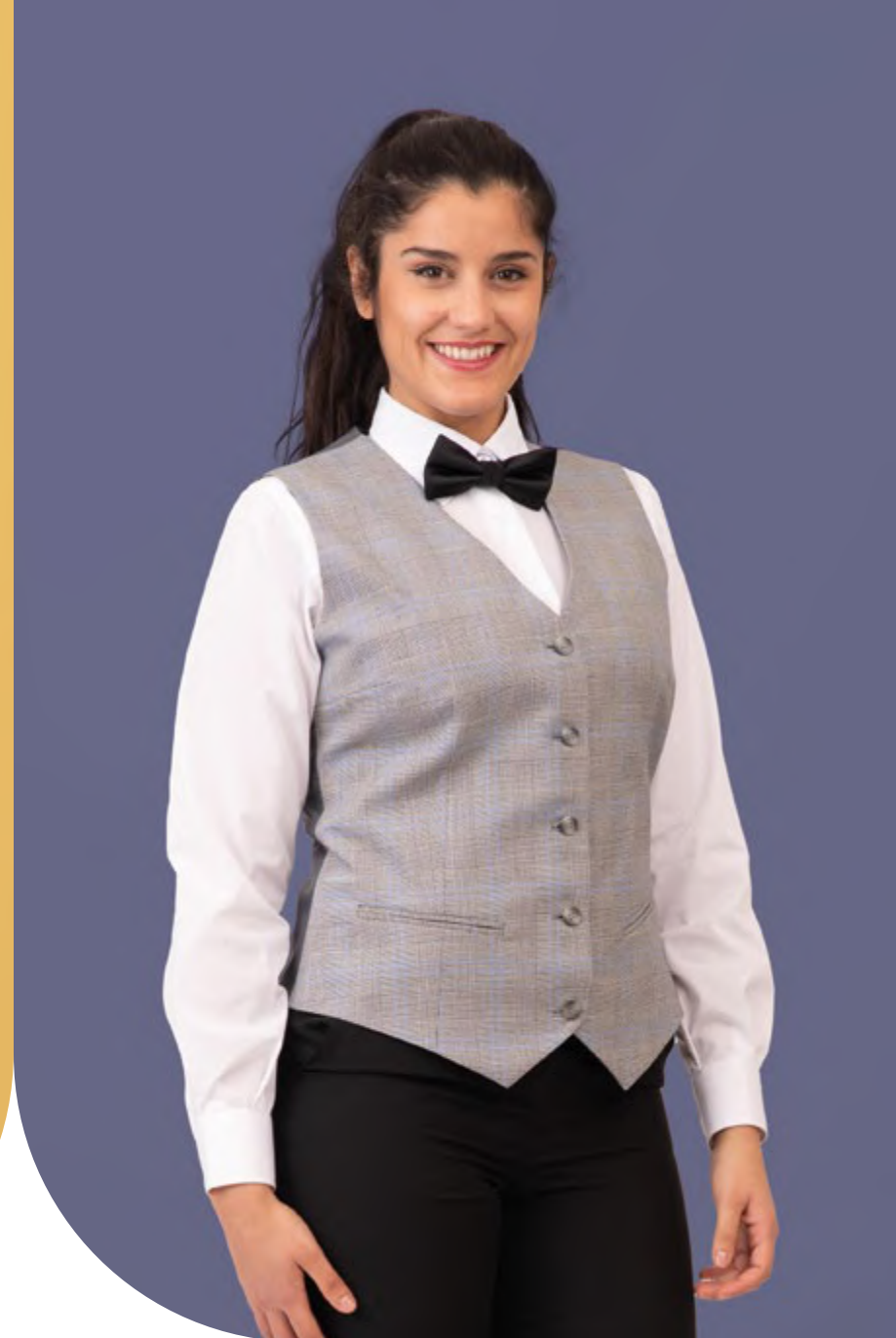

Chaleco Poliéster-Stretch

Cinco botones
Espalda tejido

Señora
Mod. 603MT6180
Serie: 6180
Tejido: Basic+

Tallas:
De la 34 a 58

Composición:
100% Poliéster Stretch
170 gr/m2

Colores:

69 Marino 99 Negro



Caballero
Mod. 603T6180
Serie: 6180
Tejido: Basic+

Tallas:
De la 40 a 68

Chaleco Príncipe de Gales

Cinco botones
Espalda de forro con ceñidor



Señora
Mod. 630M2013
Serie: 2013

Tallas:
De la 36 a 54

Composición:
65% Poliéster
35% Viscosa,
176 gr/m2

Colores:

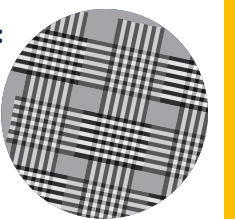

15

Caballero
Mod. 630T2013
Serie: 2013

Tallas:
De la 44 a 60



ESCAPARATE

Pantalones



Pantalones Corporativos y HoReCa

<p>Pág 39</p>  <p>Boutique S532025</p> <p>97% Algodón 3% Elastano</p>	<p>Pág 41</p>  <p>1472023</p> <p>100% Poliéster</p>	<p>Pág 43</p>  <p>Oro 2110</p> <p>100% Poliéster</p>	<p>Pág 45</p>  <p>Basic S196179</p> <p>100% Poliéster Stretch</p>	<p>Pág 44</p>  <p>Basic 1066179</p> <p>Basic S26179</p> <p>100% Poliéster Stretch</p>	<p>Pág 46</p>  <p>Basic 1036179</p> <p>Basic S206179</p> <p>100% Poliéster Stretch</p>
<p>Pág 47</p>  <p>Basic+ 1006180</p> <p>Basic+ S106180</p> <p>100% Poliéster Stretch</p>	<p>Pág 48</p>  <p>Basic+ 1116180</p> <p>Basic+ S1116180</p> <p>100% Poliéster Stretch</p>	<p>Pág 49</p>  <p>Forte 1116182</p> <p>Forte S106182</p> <p>100% Sarguita Poliéster</p>	<p>Pág 50</p>  <p>Sarga+ 1116172</p> <p>100% Poliéster</p>		
<p>Pág 51</p>  <p>Micropol 1002010</p> <p>Micropol S102010</p> <p>100% Poliéster Microfibra</p>	<p>Pág 52</p>  <p>Cómodo 1096173</p> <p>Cómodo S336173</p> <p>94% Poliéster, 6% Spandex</p>	<p>Pág 54</p>  <p>Cómodo S216173</p> <p>94% Poliéster 6% Spandex</p>	<p>Pág 55</p>  <p>Cómodo 1086173</p> <p>Cómodo S326173</p> <p>94% Poliéster, 6% Spandex</p>		

Pantalones Corporativos y HoReCa

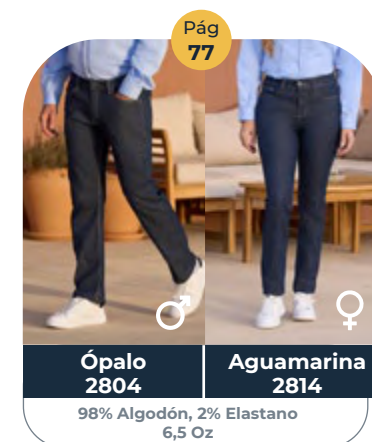
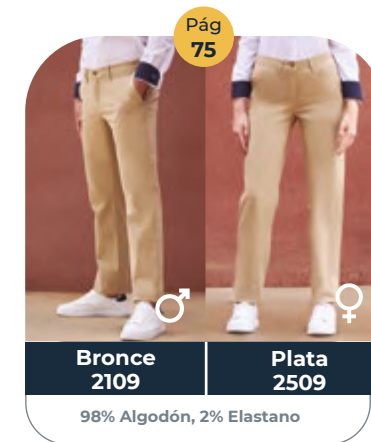
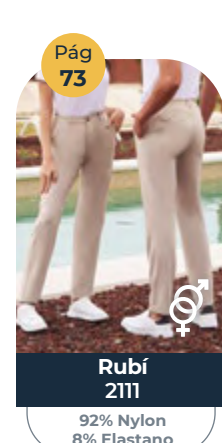
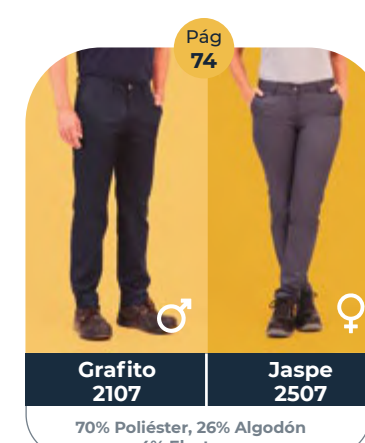
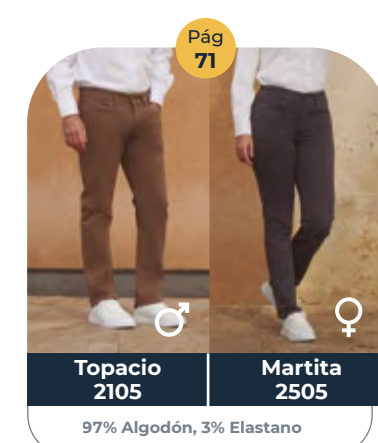
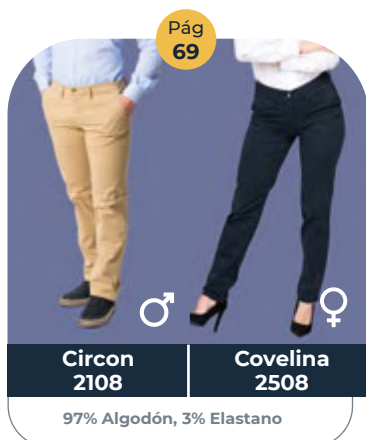
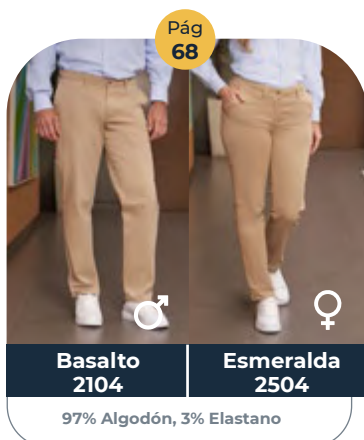
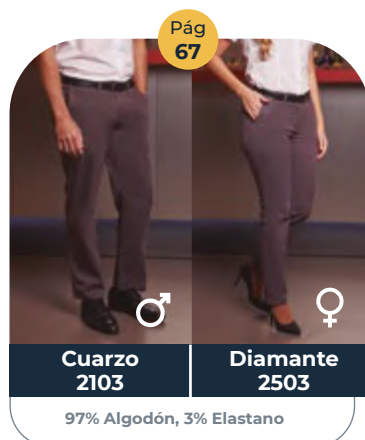
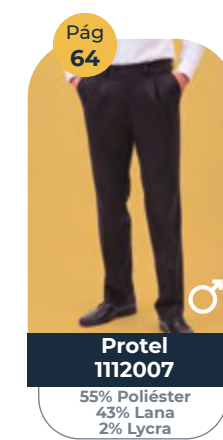
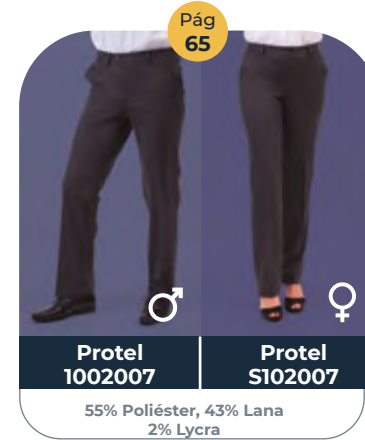
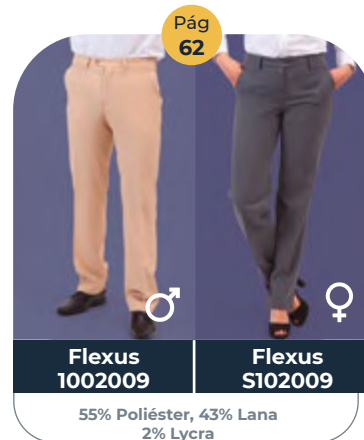
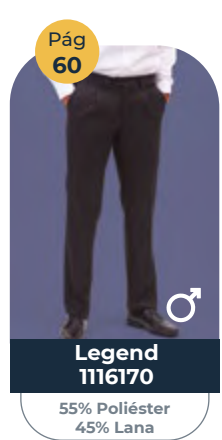
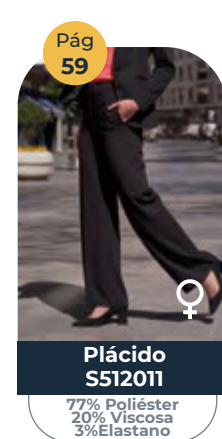

Pantalones Sanitarios, Horeca y Limpieza

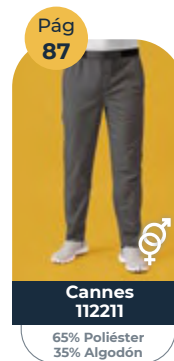

Pantalones Industria

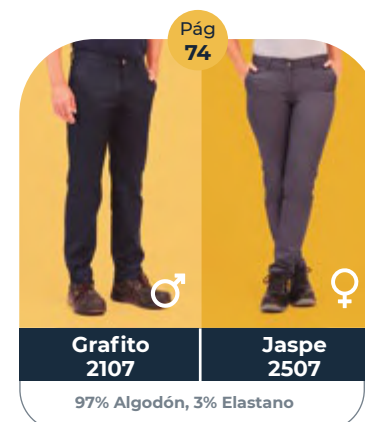



PANTALÓN Palazzo con dos bolsillos delanteros y uno trasero Señora

Mod. S532025
Serie: 2025
Tejido: Boutique

Tallas:
De la 34 a 60

Composición:
95% Poliéster
5% Elastano
200 gr/m2

Colores:  0099
Negro





PANTALÓN

Suitflex

Goma en cintura
Semipitillo

Unisex

Mod. 1472023

Serie: 2023

Tejido: Suitflex



Tallas:

De la 34 a 60

Composición:

100% Poliéster

180 gr/m2

Colores:



0030
Tostado



0004
Gris



0069
Azul
Marino



0099
Negro

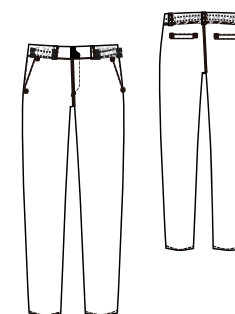



SUPER FIBRA



SUPER ELASTICO
SUPER VERSATIL
SUPER COMODO
SUPER FIBRA

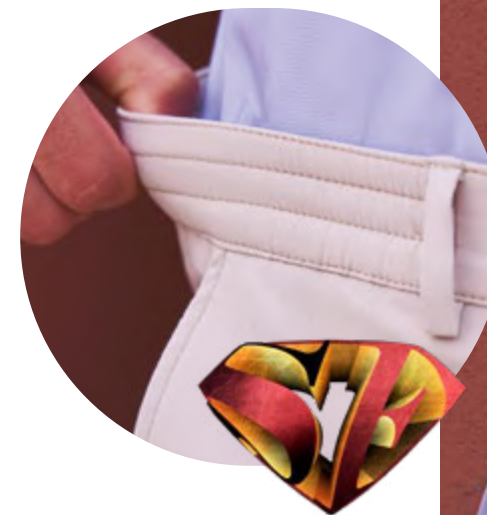

PANTALÓN SUPER FIBRA

Goma en cintura
Semipitillo
Unisex

Mod. ORO
Código: 2110
Tejido: Súper Fibra

Tallas:
De la 34 a 60

Composición:
100% Poliéster
172 gr/m²

Colores:

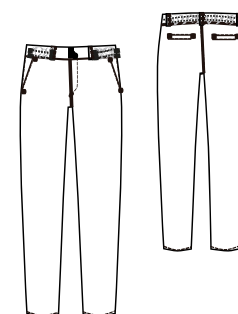
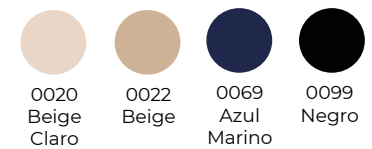



PANTALÓN Sin pliegue

Poliéster Stretch
Caballero



Mod. 1066179
Serie 6179
Tejido Basic

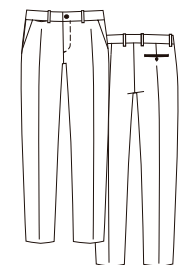

Composición:
100% Poliéster Stretch
170 gr/m²

- ▶ Sin pliegue
- ▶ Dos bolsillos tipo francés
- ▶ Bolsillo relojero
- ▶ Bolsillo trasero con dos vivos y un botón
- ▶ Tejido plana. "Stretch mecánico"

Tallas: De la 36 a la 68

Colores disponibles:

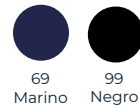

PANTALÓN Sin bolsillos

Poliéster Stretch
Señora

Mod. S26179
Serie 6179
Tejido Basic



Composición:
100% Poliéster Stretch
170 gr/m²

- ▶ Sin bolsillos traseros
- ▶ Sin bolsillos delanteros
- ▶ Tejido plana. "Stretch mecánico"

Tallas: De la 34 a la 60

Colores disponibles:

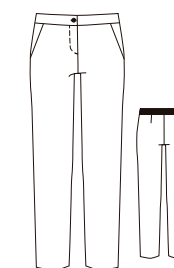
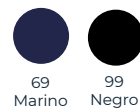

PANTALÓN con Cinturilla trasera elástica

Poliéster Stretch

Señora



Mod. S196179
Serie 6179
Tejido Basic

- ▶ Dos bolsillos tipo francés
- ▶ Sin bolsillos traseros
- ▶ Tejido plana. "Stretch mecánico"
- ▶ Media goma en cintura

Tallas:
De la 34 a 60

Composición:
100% Poliéster Stretch
170 gr/m²

Colores:

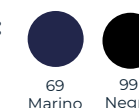



PANTALÓN Clásico

Poliéster Stretch
Caballero

Mod. 1036179
Serie 6179
Tejido Basic

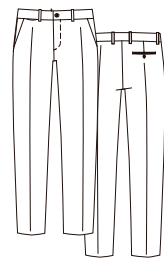

Composición:
100% Poliéster Stretch
170 gr/m²

- ▶ Un pliegue delantero
- ▶ Dos bolsillos tipo francés
- ▶ Bolsillo relojero
- ▶ Un bolsillo trasero de dos vivos con ojal y botón
- ▶ Tejido plana. "Stretch mecánico"

Tallas: De la 36 a la 68

Colores disponibles:

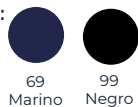

PANTALÓN Clásico

Poliéster Stretch
Señora

Mod. S206179
Serie 6179
Tejido Basic

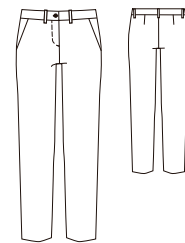

Composición:
100% Poliéster Stretch
170 gr/m²

- ▶ Dos bolsillos tipo francés
- ▶ Sin bolsillos traseros
- ▶ Tejido plana. "Stretch mecánico"

Tallas: De la 34 a la 60

Colores disponibles:

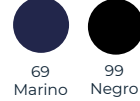

PANTALÓN Sin pliegue

Poliéster Stretch
Caballero

Mod. 1006180
Serie 6180
Tejido Basic+

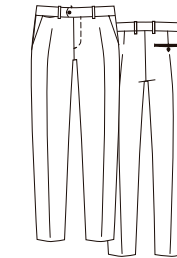

Composición:
100% Poliéster Stretch
170 gr/m²

- ▶ Sin pliegue
- ▶ Dos bolsillos tipo francés
- ▶ Bolsillo relojero
- ▶ Bolsillo trasero con dos vivos y un botón

Tallas: De la 36 a la 68

Colores disponibles:



PANTALÓN Sin bolsillos

Poliéster Stretch
Señora

Mod. S106180
Serie 6180
Tejido Basic+

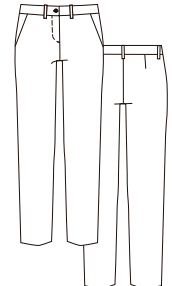

Composición:
100% Poliéster Stretch
170 gr/m²

- ▶ Dos bolsillos tipo francés
- ▶ Sin bolsillos traseros

Tallas: De la 34 a la 60

Colores disponibles:



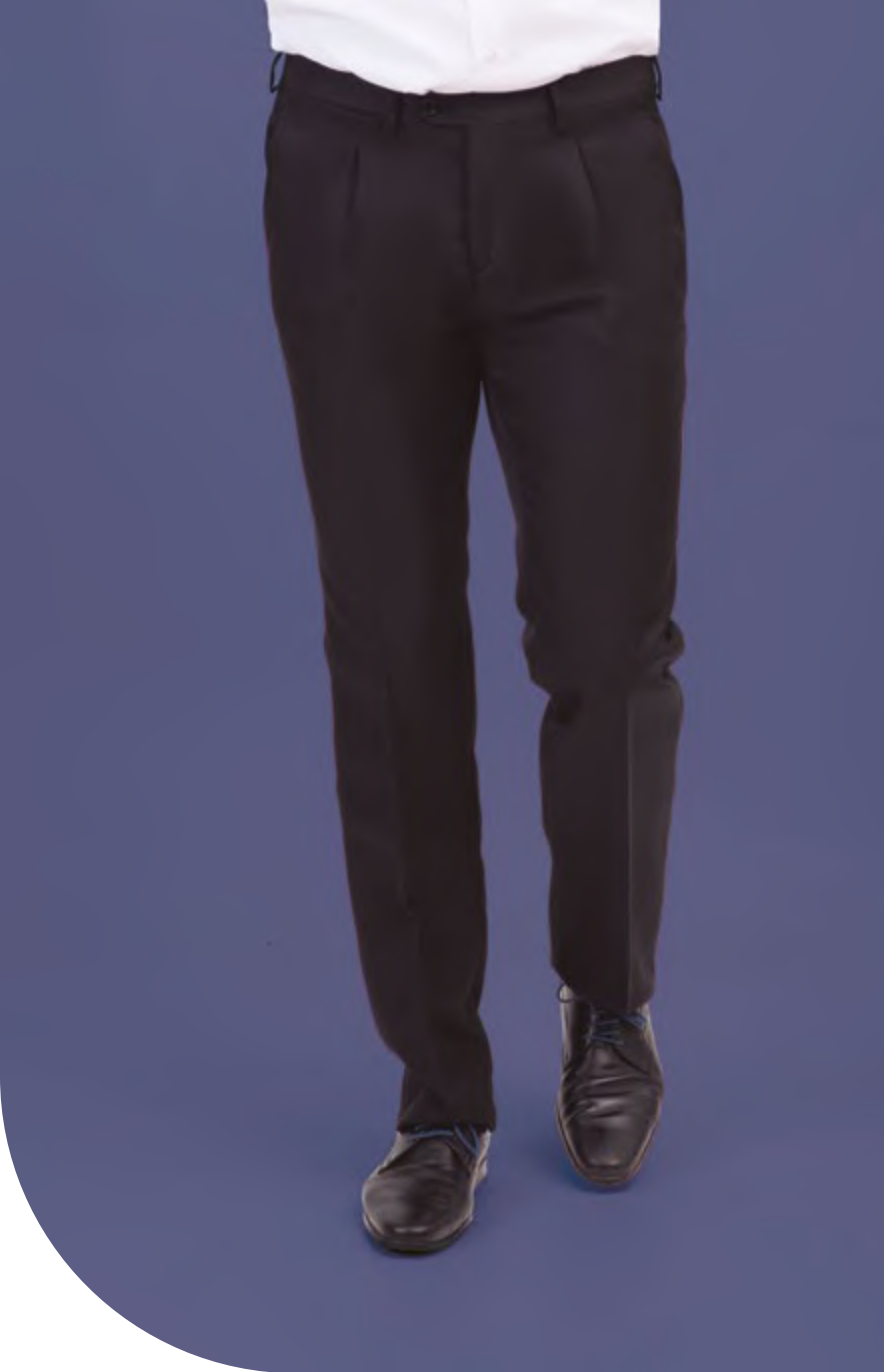

PANTALÓN Clásico

Poliéster Stretch
Caballero

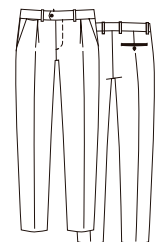

Mod. 1116180
Serie 6180
Tejido Basic+

Composición:
100% Poliéster Stretch
170 gr/m²

- ▶ Un pliegue delantero
- ▶ Dos bolsillos tipo francés
- ▶ Bolsillo relojero
- ▶ Un bolsillo trasero de dos vivos con ojal y un botón

Tallas: De la 36 a la 68

Colores disponibles:

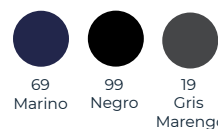

PANTALÓN Sin bolsillos

Poliéster Stretch
Señora



Mod. S26180
Serie 6180
Tejido Basic+

Composición:
100% Poliéster Stretch
170 gr/m²

- ▶ Sin bolsillos traseros
- ▶ Tejido plana. "Stretch mecánico"

Tallas: De la 34 a la 60

Colores disponibles:



PANTALÓN Clásico

Poliéster Sarga
Caballero

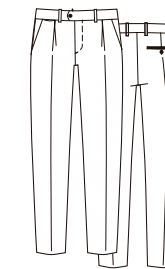

Mod. 1116182
Serie 6182
Tejido Forte

Composición:
100% Sarguita poliéster
219 gr/m

- ▶ Un pliegue delantero
- ▶ Dos bolsillos tipo francés
- ▶ Bolsillo relojero
- ▶ Un bolsillo trasero de dos vivos con ojal y un botón

Tallas: De la 36 a la 68

Colores disponibles:

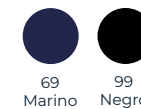

PANTALÓN Clásico

Poliéster Sarga
Señora

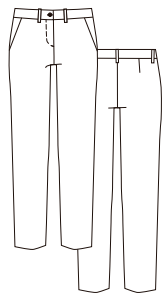

Mod. S106182
Serie 6182
Tejido Forte

Composición:
100% Sarguita poliéster
219 gr/m²

- ▶ Dos bolsillos tipo francés
- ▶ Sin bolsillos traseros

Tallas: De la 34 a la 60

Colores disponibles:

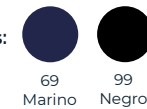

PANTALÓN Clásico

Sarga Invernal

Caballero

Mod. 1116172
Serie 6172
Tejido Sarga+

- Sarga 2x2 Invernal
- Un pliegue delantero
- Dos bolsillos tipo francés
- Bolsillo relojero
- Un bolsillo trasero de dos vivos con ojal y un botón

Tallas:
De la 36 a 68

Composición:
100% Poliéster
265 gr/m²

Colores:

69 Marino 19 Gris Marengo

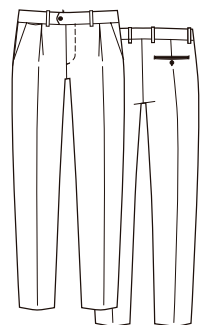

PANTALÓN Sin pliegue

Microfibra
Caballero

Mod. 1002010
Serie 2010
Tejido Micropol

Composición:
100% Poliéster, Microfibra
125 gr/m²

Tallas: De la 36 a la 68

Colores disponibles:



PANTALÓN Clásico

Microfibra
Señora

Mod. S102010
Serie 2010
Tejido Micropol

Composición:
100% Poliéster, Microfibra
125 gr/m²

Tallas: De la 34 a la 60

Colores disponibles:

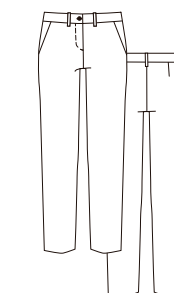
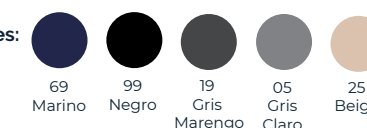

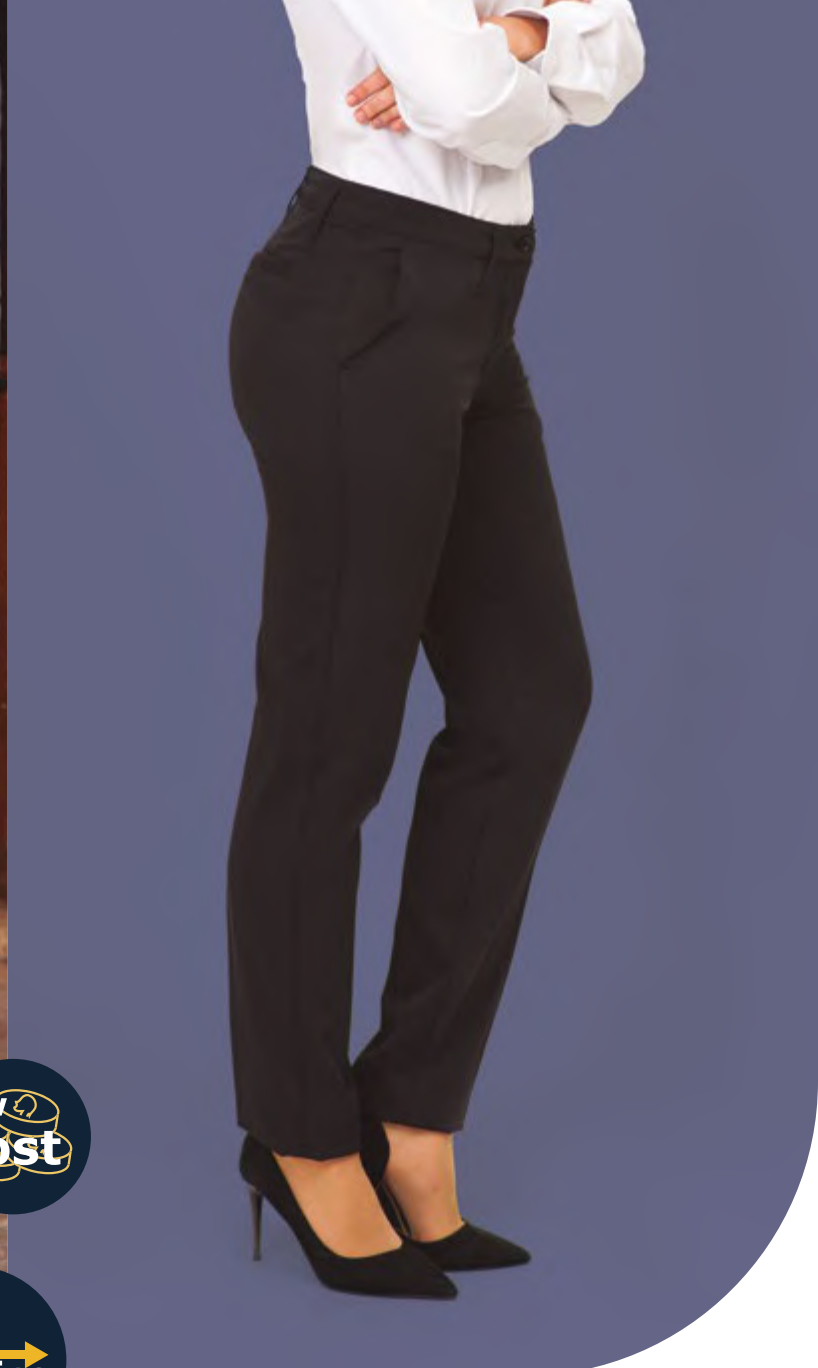

Low
Cost

Bi-
Elástico

PANTALÓN Chino

Poliéster Elástico
Caballero

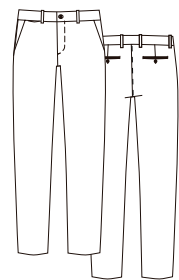

Mod. 1096173
Serie 6173
Tejido Cómodo

Composición:
94% Poliéster,
6% Spandex
215 gr/m²

- ▶ Bajo 18 cm
- ▶ Dos bolsillos tipo francés
- ▶ Bolsillo relojero
- ▶ Dos bolsillos traseros con ojal y un botón
- ▶ Elástico

Tallas: De la 36 a la 68

Colores disponibles:

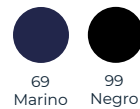

PANTALÓN Chino

Poliéster Elástico
Señora



Mod. S336173
Serie 6173
Tejido Cómodo

Composición:
94% Poliéster,
6% Spandex
215 gr/m²

- ▶ Semipitillo
- ▶ Dos bolsillos tipo francés
- ▶ Dos bolsillos Traseros
- ▶ Bielástico

Tallas: De la 34 a la 60

Colores disponibles:

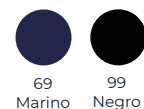

PANTALÓN Caja Baja

Microfibra
Señora

Mod. S216173
Serie 6173
Tejido Cómodo

- ▶ Bajo 18 cm
- ▶ Caja baja
- ▶ Dos bolsillos tipo francés
- ▶ Sin bolsillos Traseros
- ▶ Bielástico

Composición:
94% Poliéster,
6% Spandex,
215 gr/m²

Tallas: De la 32 a la 60

Colores disponibles:

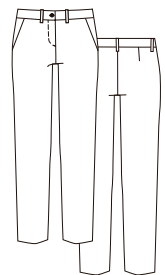
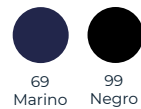

PANTALÓN Cinco Bolsillos

Poliéster Elástico
Caballero

Mod. 1086173
Serie 6173
Tejido Cómodo



Composición:
94% Poliéster,
6% Spandex,
215 gr/m²

- ▶ Bajo 18 cm
- ▶ Cinco bolsillos
- ▶ Elástico

Tallas: De la 34 a la 56

Colores disponibles:

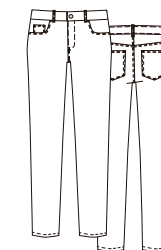

PANTALÓN Cinco Bolsillos

Poliéster Elástico
Señora

Mod. S326173
Serie 6173
Tejido Cómodo



Composición:
94% Poliéster,
6% Spandex,
215 gr/m²

- ▶ Bajo 18 cm
- ▶ Cinco bolsillos
- ▶ Elástico

Tallas: De la 32 a la 56

Colores disponibles:

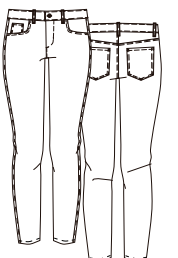



low
Cost

Bi-
Elástico

PANTALÓN Sin Pliegues

Poliéster Elástico
Caballero

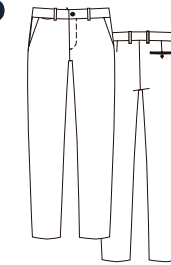

Mod. 1056173
Serie 6173
Tejido Cómodo

Composición:
94% Poliéster,
6% Spandex
215 gr/m²

- ▶ Bajo 18 cm
- ▶ Dos bolsillos tipo francés
- ▶ Bolsillo relojero
- ▶ Un bolsillo trasero con ojal y un botón
- ▶ Elástico

Tallas: De la 34 a la 62

Colores disponibles:

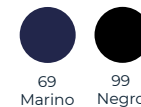

PANTALÓN de Vestir

Poliéster Elástico
Señora



Mod. S316173
Serie 6173
Tejido Cómodo

Composición:
94% Poliéster,
6% Spandex
215 gr/m²

- ▶ Semipitillo
- ▶ Dos bolsillos tipo francés
- ▶ Sin bolsillos Traseros
- ▶ Bielástico

Tallas: De la 34 a la 60

Colores disponibles:

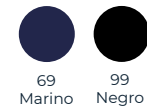



PLÁCIDO
Classic cool

Poliéster	77%
Viscosa	20%
Elastómero	3%



PANTALÓN Sin pliegue

Viscosa Elástica
Caballero

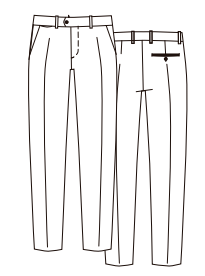

Mod. 1002011
Serie 2011
Tejido Plácido

Composición:
77% Poliéster,
20% Viscosa,
3% Elastómero
185 gr/m²

- ▶ Sin pliegue
- ▶ Dos bolsillos tipo francés
- ▶ Bolsillo relojero
- ▶ Bolsillo trasero con dos vivos y un botón

Tallas: De la 36 a la 68

Colores disponibles:

69	19	99
Marino	Gris Marengo	Negro

PANTALÓN Clásico

Viscosa Elástica
Señora

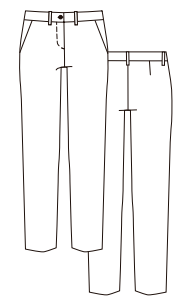

Mod. S102011
Serie 2011
Tejido Plácido

Composición:
77% Poliéster,
20% Viscosa,
3% Elastómero
185 gr/m²

- ▶ Dos bolsillos tipo francés
- ▶ Sin bolsillos traseros

Tallas: De la 34 a la 60

Colores disponibles:

69	19	99
Marino	Gris Marengo	Negro



PANTALÓN Palazzo

con dos bolsillos delanteros y uno trasero
Viscosa Elástica
Señora

Mod. S512011
Serie: 2011
Tejido: Plácido

Tallas:
De la 34 a 60

Composición:
77% Poliéster
20% Viscosa
3% Elastómero
185 gr/m²

Colores:

0099	0069
Negro	Marino

PLÁCIDO
Classic cool

Poliéster	77%
Viscosa	20%
Elastómero	3%



PANTALÓN Clásico

Sarga Lana Caballero

Mod. 1116170
Serie 6170
Tejido Legend

- Un pliegue delantero
- Dos bolsillos tipo francés
- Bolsillo relojero
- Un bolsillo trasero de dos vivos con ojal y un botón

Composición:
55% Poliéster,
45% Lana
190 gr/m²

Tallas: De la 36 a la 68

Colores disponibles:

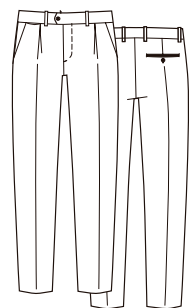

PANTALÓN Sin pliegue

Sarga Lana Caballero

Mod. 1006170
Serie 6170
Tejido Legend

Composición:
55% Poliéster,
45% Lana
190 gr/m²

- Sin pliegue
- Dos bolsillos tipo francés
- Bolsillo relojero
- Bolsillo trasero con dos vivos y un botón

Tallas: De la 36 a la 68

Colores disponibles:



PANTALÓN Clásico

Sarga Lana Señora

Mod. S106170
Serie 6170
Tejido Legend

Composición:
55% Poliéster,
45% Lana
190 gr/m²

- Dos bolsillos tipo francés
- Sin bolsillos traseros

Tallas: De la 34 a la 60

Colores disponibles:

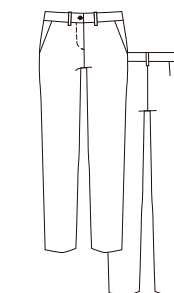

PANTALÓN Clásico

Bengalina Elástica Caballero

Mod. 1112009
Serie 2009
Tejido Flexus

- ▶ Un pliegue delantero
- ▶ Dos bolsillos tipo francés
- ▶ Bolsillo relojero
- ▶ Un bolsillo trasero de dos vivos con ojal y un botón

Composición:
43% Lana
55% Poliéster
2% Lycra®
205 gr/m²

Tallas: De la 36 a la 68

Colores disponibles:

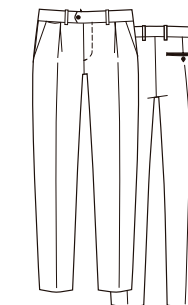
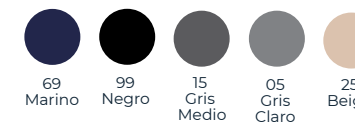

PANTALÓN Sin pliegue

Bengalina Elástica Caballero

Mod. 1002009
Serie 2009
Tejido Flexus

- Composición:**
43% Lana
55% Poliéster
2% Lycra®
205 gr/m²
- ▶ Sin pliegue
 - ▶ Dos bolsillos tipo francés
 - ▶ Bolsillo relojero
 - ▶ Bolsillo trasero con dos vivos y un botón

Tallas: De la 36 a la 68

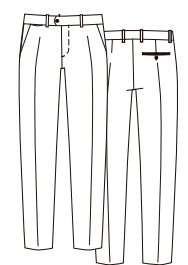

PANTALÓN Clásico

Bengalina Elástica Señora

Mod. S102009
Serie 2009
Tejido Flexus

- Composición:**
43% Lana
55% Poliéster
2% Lycra®
205 gr/m²
- ▶ Dos bolsillos tipo francés
 - ▶ Sin bolsillos traseros

Tallas: De la 34 a la 60

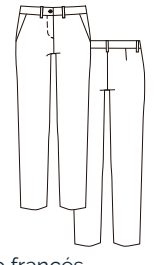

PANTALÓN Clásico

Lana Antimanchas Caballero

Mod. 1112007
Serie 2007
Tejido Protel



- Un pliegue delantero
- Dos bolsillos tipo francés
- Bolsillo relojero
- Un bolsillo trasero de dos vivos con ojal y un botón



Composición:
55% Poliéster
43% Lana
2% Lycra®
205 gr/m²

Tallas: De la 36 a la 68



Colores disponibles:

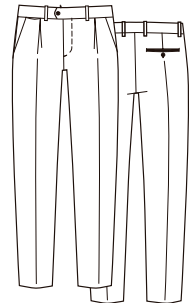

PANTALÓN Sin pliegue

Lana Antimanchas Caballero

Mod. 1002007
Serie 2007
Tejido Protel



Composición:
55% Poliéster
43% Lana
2% Lycra®
205 gr/m²

- Sin pliegue
- Dos bolsillos tipo francés
- Bolsillo relojero
- Bolsillo trasero con dos vivos y un botón

Tallas: De la 36 a la 68

Colores disponibles:

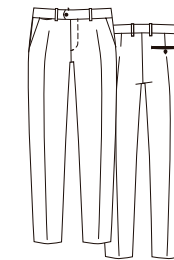

PANTALÓN Clásico

Lana Antimanchas Señora

Mod. S102007
Serie 2007
Tejido Protel

Composición:
55% Poliéster
43% Lana
2% Lycra®
205 gr/m²

- Dos bolsillos tipo francés
- Sin bolsillos traseros

Tallas: De la 34 a la 60

Colores disponibles:

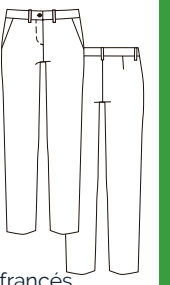



PANTALÓN Sin pliegue

Algodón Elástico

Caballero

Mod. 1052501
Serie 2501
Tejido Satén elástico



Composición:
97% algodón
3% elastano,
200 gr/m²

- ▶ Bajo 18 cm
- ▶ Dos bolsillos tipo francés
- ▶ Bolsillo relojero
- ▶ Un bolsillo trasero con ojal y un botón
- ▶ Elástico

Tallas: De la 36 a la 60

Colores disponibles:



PANTALÓN Clásico

Algodón Elástico

Señora

Mod. S312501
Serie 2501
Tejido Satén elástico



Composición:
97% algodón
3% elastano,
200 gr/m²

- ▶ Semipitillo
- ▶ Dos bolsillos tipo francés
- ▶ Sin bolsillos traseros

Tallas: De la 34 a la 54

Colores disponibles:



PANTALÓN Chino

Algodón Invernal

Caballero

Mod. Cuarzo
Código 2103
Tejido Sarga Algodón - Elastano

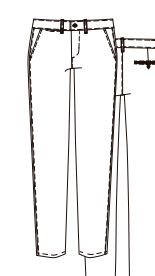

Composición:
97% algodón
3% elastano,
265 gr/m²

- ▶ Bolsillos tipo francés
- ▶ Bolsillo cerillero delantero
- ▶ Dos bolsillos traseros con ojal y botón
- ▶ Adaptación al movimiento
- ▶ Prenda sportwear.
- ▶ Mayor gramaje

Tallas: De la 36 a la 68

Colores disponibles:

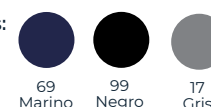

PANTALÓN Chino

Algodón Invernal

Señora

Mod. Diamante
Código 2503
Tejido Sarga Algodón - Elastano



Composición:
97% algodón
3% elastano,
265 gr/m²

- ▶ Bolsillo tipo francés
- ▶ Dos bolsillos Traseros
- ▶ Adaptación al movimiento
- ▶ Prenda sportwear
- ▶ Mayor gramaje

Tallas: De la 34 a la 58

Colores disponibles:





PANTALÓN Chino

Algodón Elástico
Caballero

Mod. Basalto
Código 2104
Tejido Sarga Algodón - Elastano



- Composición:**
97% algodón
3% elastano
250 gr/m²
- ▶ Bolsillos tipo francés
 - ▶ Bolsillo cerillero delantero
 - ▶ Dos bolsillos traseros con ojal y botón
 - ▶ Adaptación al movimiento
 - ▶ Cremallera YKK

Tallas: De la 34 a la 68

Colores disponibles:



PANTALÓN Chino

Algodón Elástico
Señora

Mod. Esmeralda
Código 2504
Tejido Sarga Algodón - Elastano

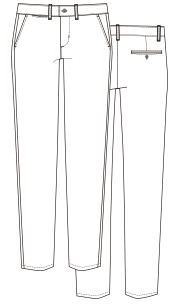

- Composición:**
97% algodón
3% elastano
250 gr/m²
- ▶ Bolsillos tipo francés
 - ▶ Dos bolsillos traseros
 - ▶ Adaptación al movimiento
 - ▶ Cremallera YKK

Tallas: De la 34 a la 58

Colores disponibles:



PANTALÓN Chino

Algodón Elástico
Caballero

Mod. Ciron
Código 2108
Tejido Sarga Algodón - Elastano

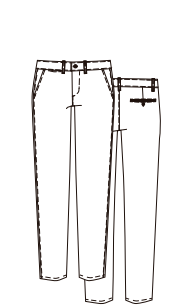

- Composición:**
97% algodón
3% elastano,
200 gr/m²
- ▶ Bolsillos tipo francés
 - ▶ Dos bolsillos traseros con ojal y botón
 - ▶ Adaptación al movimiento

Tallas: De la 36 a la 68

Colores disponibles:

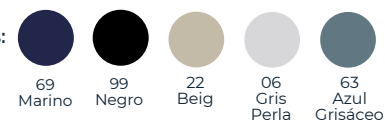

PANTALÓN Chino

Algodón Elástico
Señora

Mod. Covelina
Código 2508
Tejido Sarga Algodón - Elastano

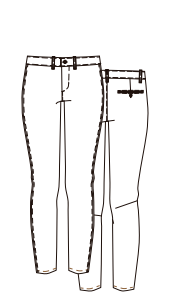

- Composición:**
97% algodón
3% elastano,
200 gr/m²
- ▶ Dos bolsillos delanteros
 - ▶ Dos bolsillos traseros

Tallas: De la 34 a la 60

Colores disponibles:

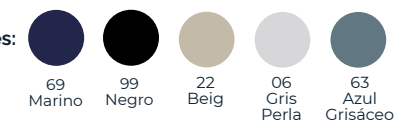



PANTALÓN Pitillo

Algodón Elástico
Caballero

Mod. Granada
Código 2106
Tejido Sarga Algodón - Elastano



- Composición:**
97% algodón
3% elastano,
200 gr/m²
- ▶ Bolsillos tipo francés
 - ▶ Dos bolsillos traseros con ojal y botón
 - ▶ Adaptación al movimiento

Tallas: De la 36 a la 60

- Colores disponibles:
- 69 Marino
 - 99 Negro
 - 22 Beig
 - 06 Gris Perla
 - 63 Azul Grisáceo
 - 76 Verde Gaqui

PANTALÓN Pitillo

Algodón Elástico
Señora

Mod. Abalone
Código 2506
Tejido Sarga Algodón - Elastano



- Composición:**
97% algodón
3% elastano,
200 gr/m²
- ▶ Dos bolsillos Traseros
 - ▶ Adaptación al movimiento
 - ▶ Prenda sportwear

Tallas: De la 34 a la 50

- Colores disponibles:
- 69 Marino
 - 99 Negro
 - 22 Beig
 - 06 Gris Perla
 - 63 Azul Grisáceo
 - 76 Verde Gaqui

PANTALÓN Chino

Algodón Elástico
Caballero

Mod. Topacio
Código 2105
Tejido Elástika

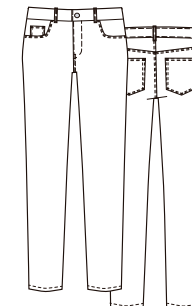

- Composición:**
97% algodón
3% elastano,
250 gr/m²
- ▶ Tipo cinco bolsillos
 - ▶ Adaptación al movimiento
 - ▶ Prenda sportwear

Tallas: De la 34 a la 60

- Colores disponibles:
- 69 Marino
 - 99 Negro
 - 35 Caqui
 - 17 Gris Medio
 - 22 Beige

PANTALÓN Chino

Algodón Elástico
Señora

Mod. Martita
Código 2505
Tejido Elástika

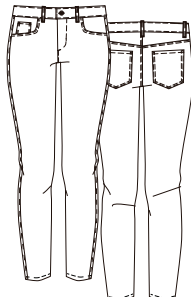

- Composición:**
97% algodón
3% elastano,
250 gr/m²
- ▶ Tipo cinco bolsillos
 - ▶ Adaptación al movimiento
 - ▶ Prenda sportwear
 - ▶ Elástico

Tallas: De la 34 a la 58

- Colores disponibles:
- 69 Marino
 - 99 Negro
 - 35 Caqui
 - 17 Gris Medio
 - 22 Beige



OASIX
Un espejismo hecho realidad



1° Resistencia a los rayos UVA



2° Alta transpirabilidad y frescura



3° Bielástico y ultra cómodo



4° Hidrofugado



5° Ligero



6° Unisex



OASIX

Un espejismo hecho realidad

PANTALÓN
OASIX
Goma en cintura
Semipitillo

Unisex

Mod. RUBÍ

Código: 2111

Tejido: Oasis

Tallas:

De la 34 a 60

Composición:

92% Nylon

8% Elastano

135 gr/m²

Colores:



0020
Beige
Claro



0069
Azul
Marino



0099
Negro

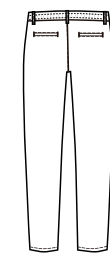
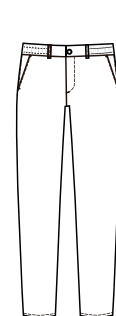

PANTALÓN

Hidrofugado

Caballero y Señora

Señora.

Mod. Jaspe
Código 2507

- ▶ Bolsillos tipo francés
- ▶ Resistente al pilling
- ▶ Adaptación al movimiento
- ▶ Hidrofugado
- ▶ Durabilidad del color

Composición:
70% Poliéster,
26% Algodón
4% Elastano,
240 gr/m²

Tallas: De la 32 a la 60

Colores disponibles:

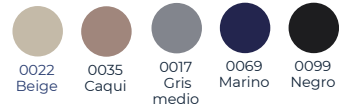

Caballero.

Mod. Grafito
Código 2107

- ▶ Bolsillos tipo francés
- ▶ Dos bolsillos traseros con ojal y botón
- ▶ Resistente al pilling
- ▶ Adaptación al movimiento
- ▶ Hidrofugado
- ▶ Durabilidad del color

Composición:
70% Poliéster,
26% Algodón
4% Elastano, 240 gr/m²

Tallas: De la 34 a la 68

Colores disponibles:



*Pruebas realizadas por AITEX



PANTALÓN Chino

Algodón Elástico

Caballero

Mod. Bronce
Código 2109



Composición:
98% algodón
2% elastano

- ▶ Bolsillos tipo francés
- ▶ Bolsillo cerillero delantero
- ▶ Dos bolsillos traseros con ojal y botón
- ▶ Adaptación al movimiento
- ▶ Cremallera YKK

Tallas: De la 34 a la 60

Colores disponibles:

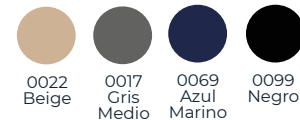

PANTALÓN Chino

Algodón Elástico

Señora

Mod. Plata
Código 2509



Composición:
98% algodón
2% elastano

- ▶ Bolsillos tipo francés
- ▶ Dos bolsillos traseros
- ▶ Adaptación al movimiento
- ▶ Cremallera YKK

Tallas: De la 34 a la 58

Colores disponibles:



PANTALÓN

Denim Elástico

Caballero y Señora



Señora

Mod. Silvana
Código 2815

- ▶ Vaquero
- ▶ Elástico
- ▶ Cinco bolsillos
- ▶ Adaptación al movimiento

Composición:
98% Algodón
2% Elastano
10,5 Oz (300 gr/m²)

Tallas: De la 34a la 58

Colores disponibles:



0165
Denim



Caballero

Mod. Ilvita
Código 2805

- ▶ Vaquero
- ▶ Elástico
- ▶ Cinco bolsillos
- ▶ Adaptación al movimiento

Composición:
98% Algodón
2% Elastano
10,5 Oz (300 gr/m²)

Tallas: De la 36 a la 60

Colores disponibles:



0165
Denim

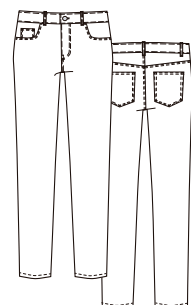

PANTALÓN Cinco Bolsillos Denim Verano Caballero



Mod. Ópalo
Código 2804

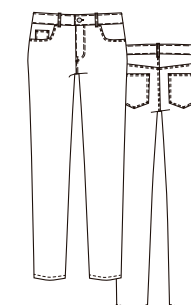

Composición:
98% Algodón,
2% Elastano
6,50 Oz (185 gr/m²)

- ▶ Vaquero
- ▶ Tipo cinco bolsillos
- ▶ Lavado a la piedra

Tallas: De la 36 a la 60

Colores disponibles:



0165
Denim

PANTALÓN Cinco Bolsillos Denim Verano Señora

Mod. Aguamarina
Código 2814

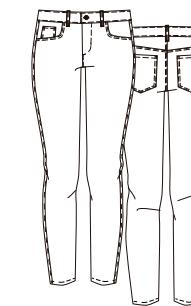

Composición:
98% Algodón,
2% Elastano
6,50 Oz (185 gr/m²)

- ▶ Vaquero
- ▶ Tipo cinco bolsillos
- ▶ Lavado a la piedra
- ▶ Elástico

Tallas: De la 34 a la 58

Colores disponibles:



0165
Denim

Pantalón Vaquero

Media Goma

Unisex

Mod. Gante

Código 112002

Tallas:

De la XS a la 4XL

Composición:

98% Algodón

2% Elastano

6,5 Oz (185 gr/m²)



Colores:



65 Denim



Elastico

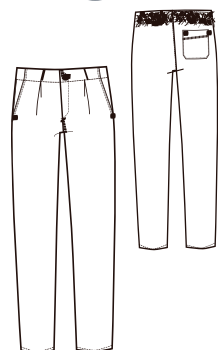

Pantalón

Goma entera

Unisex

Mod. Ans

Código 112201 Blanco (Solitec Plus +)

Código 112201C Colores (Solitec)

Tallas:

De la 3XS a la 6XL (en blanco)

De la 3XS a la 4XL (resto de colores)

Composición:

65% Poliéster

35% Algodón

195 gr/m²

Colores:

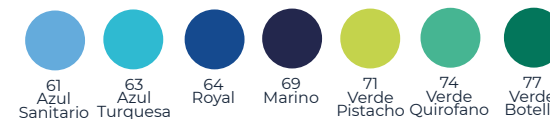
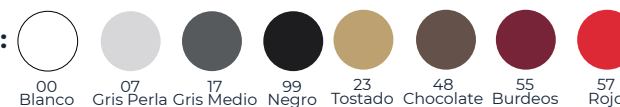

Pantalón

Media Goma

Unisex

Mod. Amberes

Código 112001 Blanco

Código 112001C Colores

Tallas:

De la XS a la 4XL

Composición:

65% Poliéster

35% Algodón

195 gr/m²

Colores:





Pantalón Microfibra

Con cordón, goma entera, 3 bolsillos

Unisex

Mod. Mons
 Código 112204 Blanco
 Código 112204C Colores

Tallas:
 De la XS a la 4XL

Composición:
 100% Poliéster
 160 gr/m²

Colores:

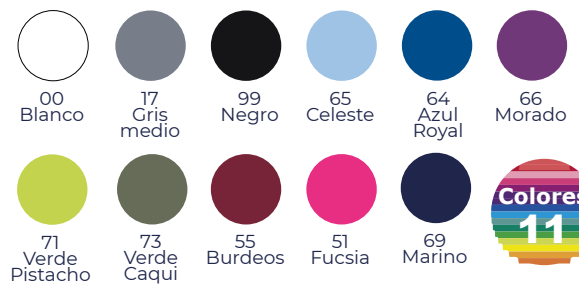

Pantalón Microfibra

Goma entera y un bolsillo

Unisex

Mod. Arlon
 Código 112207 Blanco
 Código 112207C Colores

Tallas:
 De la XS a la 4XL

Composición:
 100% Poliéster
 160 gr/m²

Colores:

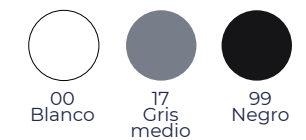



Pantalón Jogger

Microfibra, tejido elástico y Puño en bajo Unisex

Mod. Gent
Código 112208

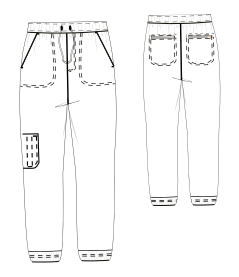

Tallas:
De la XS a la 3XL

Composición:
100% Poliéster
132 gr/m²



- | | | | | |
|--------------------|------------------|----------------|-------------|------------|
| | | | | |
| 2072 Agua | 2065 Celeste | 2068 Petróleo | 2000 Blanco | 2099 Negro |
| | | | | |
| 2073 Verde Militar | 2069 Azul Marino | 2056 Remolacha | 2017 Gris | 2047 Coral |

Pantalón Sport

Microfibra, tejido elástico, nido de abeja y goma cintura elástica Unisex

Mod. Eupen
Código 112209

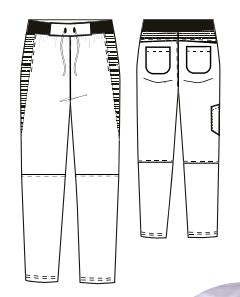

Tallas:
De la XS a la 3XL

Composición:
100% Poliéster
132 gr/m²

- Colores:**
- | | | |
|--------------------|----------------|------------|
| | | |
| 2068 Petróleo | 2000 Blanco | 2099 Negro |
| | | |
| 2073 Verde Militar | 2056 Remolacha | 2017 Gris |

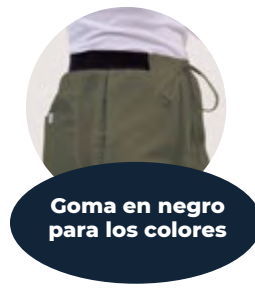

Pantalón Todo Goma

Microfibra, tejido elástico, 1 bolsillo Unisex

Mod. Biarritz
Código 112215

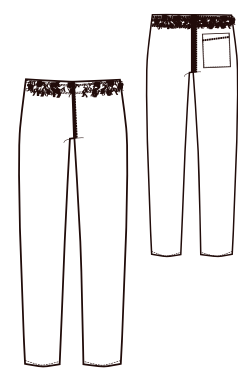

Tallas:
De la XS a la 3XL

Composición:
100% Poliéster
132 gr/m²



- | | | | | |
|--------------------|------------------|----------------|-------------|------------|
| | | | | |
| 2072 Agua | 2065 Celeste | 2068 Petróleo | 2000 Blanco | 2099 Negro |
| | | | | |
| 2073 Verde Militar | 2069 Azul Marino | 2056 Remolacha | 2017 Gris | 2047 Coral |

Pantalón Todo Goma

Microfibra, tejido elástico, 2 bolsillos Unisex

Mod. Baiona
Código 112216



Tallas:
De la XS a la 3XL

Composición:
100% Poliéster
132 gr/m²



- | | | | | |
|--------------------|------------------|----------------|-------------|------------|
| | | | | |
| 2072 Agua | 2065 Celeste | 2068 Petróleo | 2000 Blanco | 2099 Negro |
| | | | | |
| 2073 Verde Militar | 2069 Azul Marino | 2056 Remolacha | 2017 Gris | 2047 Coral |

Pantalón

Poliéster Reciclado

Microfibra, Goma entera
Unisex

Mod. Hendaya

Código 112250

Tallas:

De la XS a la 3XL

Composición:

44% Poliéster Reciclado
56% Poliéster Convencional
160 gr/m²

Colores:

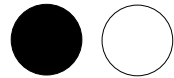

0099
Negro

0000
Blanco



Pantalón

Goma Entera

Popelín, Fresco
Unisex

Mod. Spa

Código 112203

Tallas:

De la XS a la 4XL

Composición:

65% Poliéster
35% Algodón
105 gr/m²

Colores:



0099
Negro

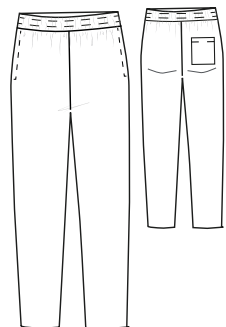



Pantalón Goma Elástica

Popelín Vigoré y Nido de Abeja
Unisex

Mod. Cannes
Código 112211

Tallas:
De la XS a la 3XL

Composición:
65% Poliéster
35% Algodón
108 gr/m²

Nido de abeja:
100% poliéster
125 gr/m²

Colores:

- 0099 Negro
- 0017 Gris Medio
- 0069 Marino

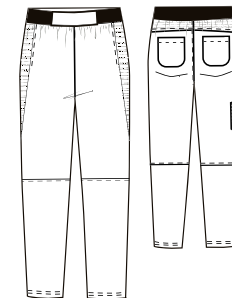

Pantalón Económico

Popelín Vigoré y Goma entera
Unisex

Mod. Aviñón
Código 112212

Tallas:
De la XS a la 3XL

Composición:
65% Poliéster
35% Algodón
108 gr/m²

Colores:

- 0099 Negro
- 0017 Gris Medio
- 0069 Marino

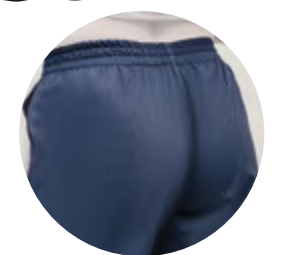

PANTALÓN

Rayas

Media Goma
Unisex



Mod. Namur
Código 112402

Tallas:
De la XS a la 4XL

Composición:
65% Poliéster
35% Algodón
165 gr/m²

Colores:

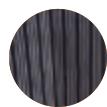

103
Negro/Gris

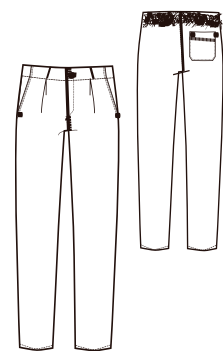

Pantalón Cuadros

Media Goma
Unisex



Mod. Namur
Código 112401

Tallas:
De la XS a la 4XL

Composición:
50% Poliéster
50% Algodón
110 gr/m²

Colores:

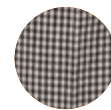

101
Negro

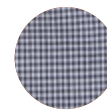

102
Azul



Pantalón Cuadros

Goma entera
Unisex

Mod. Ans
Código 112202

Tallas:
De la 3XS a la 3XL

Composición:
50% Poliéster
50% Algodón
110 gr/m²

Colores:

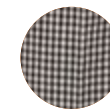

101
Negro

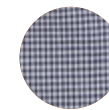

102
Azul

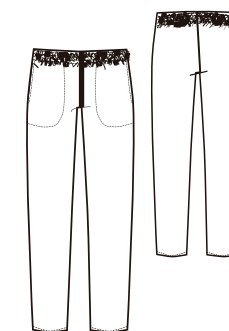



Los tejidos del Futuro ya son Presente

NanoTec Technology

Con esta **tecnología revolucionaria** hemos creado una composición química a nivel molecular que se le aplica al tejido y que le da unas **propiedades hidrófugas**. Con ello conseguimos que las prendas tengan una **durabilidad** mas alta sin perder sus prestaciones.



NanuTec "El Camaleón de los Tejidos"

Desde hace años hemos utilizado esta hilatura propia para conseguir una segunda piel con nuestros productos térmicos que hacen que seamos **número uno en el sector**. Pioneros en testar estas prendas en laboratorio con notas sensacionales.

Hay muchas prendas térmicas, pero sólo un **NANUTEC**.

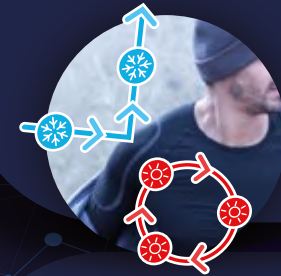

Un **tejido inteligente** que destaca por tener una gran adaptabilidad a la temperatura externa, ya que cuando hace frío se cierra para que este no pase y así mantener el calor.

SOLITEC INDUSTRY polycotton económico



Durabilidad del color



Mercerizado



Sanforizado



Resistente al pilling



Tejido elástico



Plancha fácil

SOLITEC STRETCH polycotton elástico



Durabilidad del color



Colores limpios



Repelente a líquidos



Resistente al pilling



Tejido elástico



Plancha fácil

SOLITEC polycotton



Durabilidad del color



Colores limpios



Resistente al pilling

SOLITEC PLUS+ polycotton anti-pilling

Las innovadoras fibras largas de algodón peinado Solitec Plus + le aportan mayor resistencia al pilling.



THERMOLITE

- Ayuda a mantenerse fresco.
- Seco y confortable.
- Mantiene la temperatura corporal.
- Tejido transpirable
- De secado rápido
- Flexible y ligero
- Se puede lavar a máquina

COOLMAX

- Ayuda a mantenerse fresco.
- Seco y confortable.
- Tejido transpirable.
- De secado rápido.
- Flexible y ligero.
- Se puede lavar a máquina.

PANTALÓN

Multibolsillos

Unisex



Mod. Imuna
Código 2404

- ▶ Pantalón elástico
- ▶ Hidrofugado
- ▶ Bolsillos con tapeta
- ▶ Tiradores Poliéster
- ▶ Refuerzo en culera
- ▶ Corte Fit

Composición:
70% Poliéster
26% Algodón
4% Elastano
240 gr/m²

Unisex
Unisex

Tallas:
De la 34 a la 68

Colores:

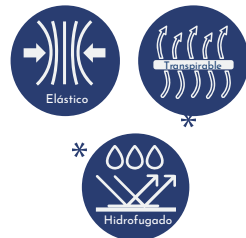
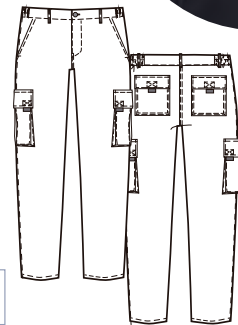
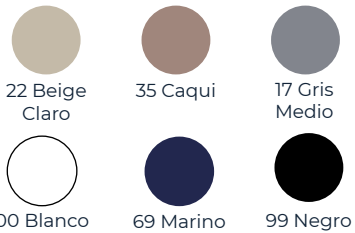

*Pruebas realizadas por AITEX

NanoTec



Testado con **Aitex**



ENSAYOS REALIZADOS CON ÓPTIMOS RESULTADOS

- Resistencia a la formación de pilling. ✓
- Permeabilidad al vapor de agua (transpirabilidad). ✓
- Alargamiento y recuperado, bajo carga, por tracción. ✓
- Solidez de las tinturas al lavado. ✓
- Solidez de las tinturas al frote. ✓
- Solidez del color a la transpiración. ✓
- Solidez de las tinturas al agua. ✓
- Pretratamiento de lavado y secado industrial para los ensayos textiles. ✓
- Inspección visual tras el lavado / tras 5 ciclos de lavado a 75°C, según norma en ISO 15797 y secado tipo A. ✓
- Resistencia a la costura. ✓
- Solidez de las tinturas al blanqueo con hipoclorito. ✓
- Significado de los índices de solidez valorados con escala de grises. ✓





PANTALÓN

Multibolsillos

ULTRACONFORT

Unisex

Mod. Olympus
Código 2403

- ▶ Tejido elástico
- ▶ Corte Slim
- ▶ Bolsillos con tapeta
- ▶ Cremallera YKK
- ▶ Mercerizado y sanforizado
- ▶ Plancha Fácil

Composición:
60% Poliéster
37% Algodón
3% Elastán
240 gr/m²

Tallas:
De la 34 a la 68

Colores:

- 69 Marino
- 99 Negro
- 17 Gris Medio

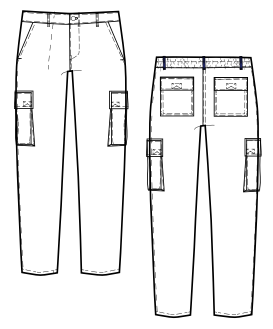

Durabilidad del color	Mercerizado	Sanforizado
Resistente al pilling	Tejido elástico	Plancha fácil

PANTALÓN

Denim

Extra Bolsillos

Caballero y Señora



Señora.

Mod. Ámbar
Código 2813

- ▶ Vaquero
- ▶ Tipo cinco bolsillos
- ▶ Bolsillos supletorios en pierna
- ▶ Elástico
- ▶ Lavado a la piedra

Composición:
97% Algodón,
3% Elastano
9,05 Oz (270 gr/m2)

Tallas: De la 34 a la 60

Colores disponibles:



0165
Denim

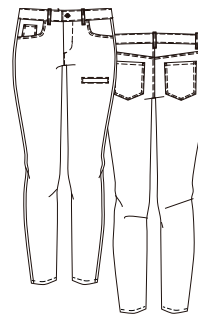

Caballero.

Mod. Ónix
Código 2803

- ▶ Vaquero
- ▶ Tipo cinco bolsillos
- ▶ Bolsillos supletorios en pierna
- ▶ Elástico
- ▶ Lavado a la piedra

Composición:
97% Algodón,
3% Elastano
9,05 Oz (270 gr/m2)

Tallas: De la 36 a la 60

Colores disponibles:

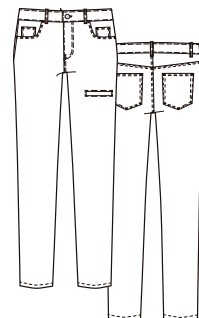

ESCAPARATE

Bermudas, Faldas y Vestidos

Bermudas

Vestidos



Pág 99

NÁCAR
112600

100% Poliéster

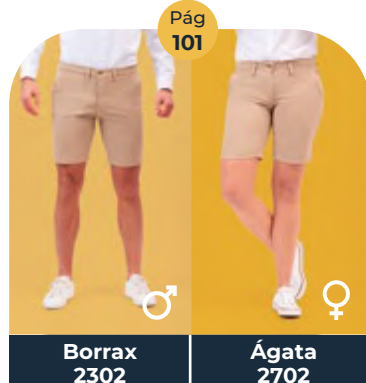

Pág 101

Borrax
2302

97% Algodón, 3% Elastano

Ágata
2702



Pág 100

Papua
2311

70% Poliéster
26% Algodón
4% Elastano

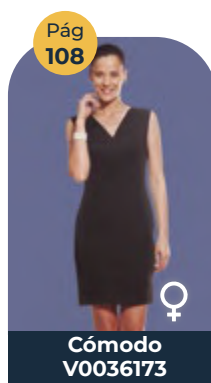

Pág 108

Cómodo
V0036173

94% Poliéster
6% Spandex

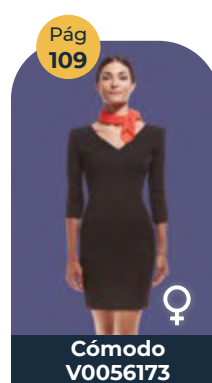

Pág 109

Cómodo
V0056173

94% Poliéster
6% Spandex

Faldas

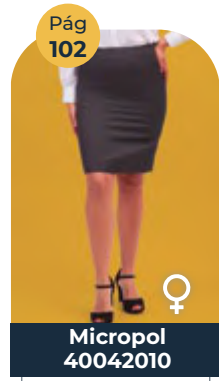

Pág 102

Micropol
40042010

100% Poliéster
Microfibra

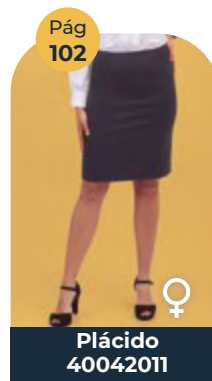

Pág 102

Plácido
40042011

77% Poliéster
20% Viscosa
3% Elastano

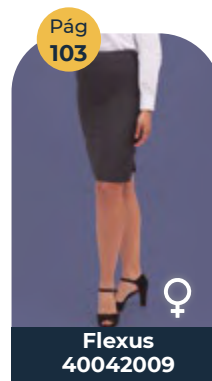

Pág 103

Flexus
40042009

55% Poliéster
43% Lana
2% Lycra

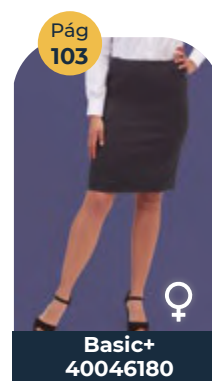

Pág 103

Basic+
40046180

100% Poliéster
Stretch



Pág 104

Forte
40046182

100% Poliéster
Sargueta



Pág 104

Legend
40046170

55% Poliéster
45% Lana

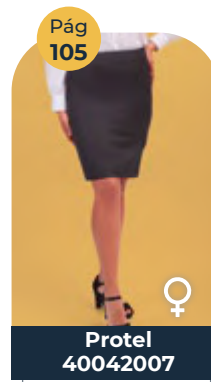

Pág 105

Protel
40042007

43% Lana
55% Poliéster
2% Lycra

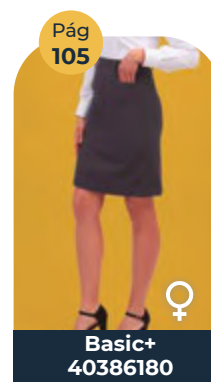

Pág 105

Basic+
40386180

100% Poliéster
Stretch



Pág 106

Flexus
40422009

55% Poliéster
43% Lana
2% Lycra

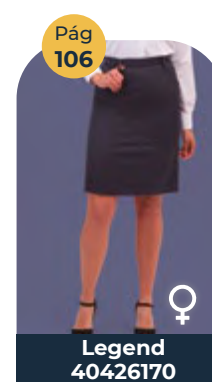

Pág 106

Legend
40426170

55% Poliéster
45% Lana



Pág 107

Plácido
41032011

77% Poliéster
20% Viscosa
3% Elastano



Bermuda Microfibra

Todo goma y 3 bolsillo

Unisex



HidroFlex
Microfibra

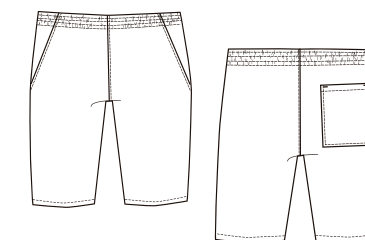

Mod. NÁCAR
Código 112600

Composición:
100% Poliéster
132 gr/m²

Tallas:
De la XS a la 4XL

Colores:

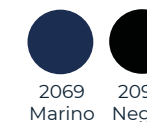

BERMUDA

Multibolsillos

Unisex



Mod. Papua
Código 2311

- Bermuda elástica
- Hidrofugado
- Bolsillos con tapeta
- Tiradores Poliéster
- Refuerzo en culera
- Corte Fit

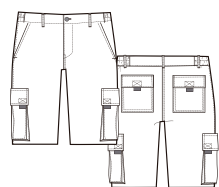

Composición:
70% Poliéster
26% Algodón
4% Elastano
240 gr/m²

Tallas: De la 34 a la 68

Colores disponibles:

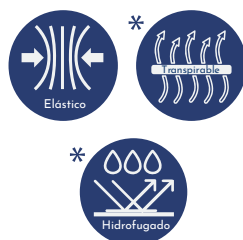
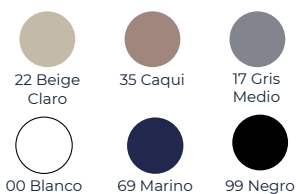

*Pruebas realizadas por AITEX



BERMUDA

Algodón Elástico
Caballero



Mod. Borrax
Código 2302
Tejido Elástica

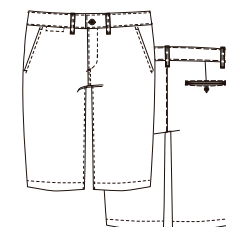

Composición:
97% algodón
3% elastano,
200 gr/m²

Tallas: De la 36 a la 62

Colores disponibles:

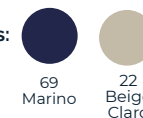

- Bolsillos tipo francés
- Dos bolsillos Traseros
- Bolsillo cerillero delantero
- Adaptación al movimiento
- Prenda sportwear

BERMUDA

Algodón Elástico
Señora

Mod. Ágata
Código 2702
Tejido Elástica

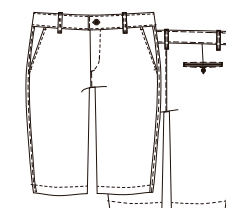

Composición:
97% algodón
3% elastano,
200 gr/m²

Tallas: De la 34 a la 58

Colores disponibles:

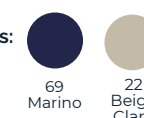

- Bolsillo tipo francés
- Dos bolsillos Traseros
- Adaptación al movimiento
- Prenda sportwear

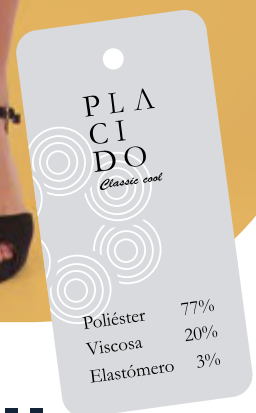

FALDA Sin Cinturilla

Microfibra
Señora

Mod. 40042010
Serie 2010
Tejido Micropol

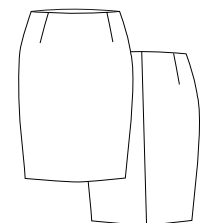

Composición:
100% Poliéster Microfibra
195 gr/m²

- ▶ Forrada
- ▶ Sin cinturilla
- ▶ Sin bolsillos
- ▶ Cierre Cremallera invisible
- ▶ Una abertura trasera

Tallas: De la 34 a la 58

Colores disponibles:



FALDA Sin Cinturilla

Viscosa Elástica
Señora

Mod. 40042011
Serie 2011
Tejido Plácido

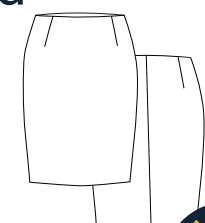

Composición:
77% Poliéster,
20% Viscosa,
3% Elastómero
185 gr/m²

- ▶ Forrada
- ▶ Sin cinturilla
- ▶ Sin bolsillos
- ▶ Cierre Cremallera invisible
- ▶ Una abertura trasera

Tallas: De la 34 a la 58

Colores disponibles:



FALDA Sin Cinturilla

Bengalina elástica
Señora

Mod. 40042009
Serie 2009
Tejido Flexus



Composición:
43% Lana
55% Poliéster
2% Lycra, 205 gr/m²

- ▶ Forrada
- ▶ Sin cinturilla
- ▶ Sin bolsillos
- ▶ Cierre Cremallera invisible
- ▶ Una abertura trasera

Tallas: De la 34 a la 58

Colores disponibles:



FALDA Sin Cinturilla

Poliéster Stretch
Señora

Mod. 40046180
Serie 6180
Tejido Basic+

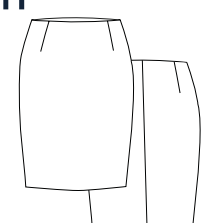

Composición:
100% poliéster stretch
195 gr/m²

- ▶ Forrada
- ▶ Sin cinturilla
- ▶ Sin bolsillos
- ▶ Cierre Cremallera invisible
- ▶ Una abertura trasera

Tallas: De la 34 a la 58

Colores disponibles:





FALDA Sin Cinturilla

Poliéster Sarga
Señora

Mod. 40046182
Serie 6182
Tejido Forte

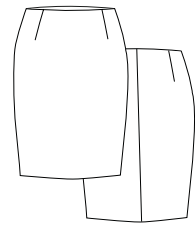

Composición:
100% Sargueta Poliéster
219 gr/m²

- Forrada
- Sin cinturilla
- Sin bolsillos
- Cierre Cremallera invisible
- Una abertura trasera

Tallas: De la 34 a la 58

Colores disponibles:

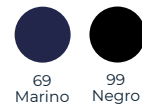

FALDA Sin Cinturilla

Sarga Lana
Señora

Mod. 40046170
Serie 6170
Tejido Legend

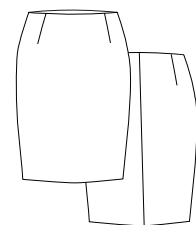

Composición:
45% lana
55% Poliéster,
190 gr/m²

- Forrada
- Sin cinturilla
- Sin bolsillos
- Cierre Cremallera invisible
- Una abertura trasera

Tallas: De la 34 a la 58

Colores disponibles:

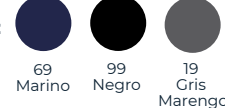

FALDA Sin Cinturilla

Lana Antimanchas
Señora

Mod. 40042007
Serie 2007
Tejido Protel



Composición:
43% Lana,
55% Poliéster
2% Lycra
205 gr/m²

- Forrada
- Sin cinturilla
- Sin bolsillos
- Cierre Cremallera invisible
- Una abertura trasera

Tallas: De la 34 a la 58

Colores disponibles:

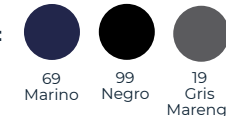

FALDA Con bolsillos

Poliéster Stretch
Señora

Mod. 40386180
Serie 6180
Tejido Basic+

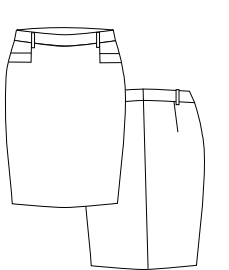

Composición:
100% poliéster stretch
195 gr/m²

- Forrada
- Con cinturilla y trabillas
- Cierre cremallera invisible
- Una abertura trasera
- Con bolsillos

Tallas: De la 34 a la 58

Colores disponibles:

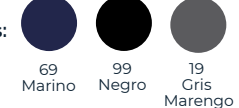



FALDA Sin Bolsillos

Bengalina elástica
Señora

Mod. 40422009
Serie 2009
Tejido Flexus

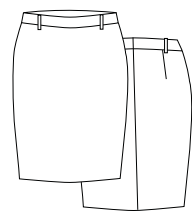

Composición:
43% Lana
55% Poliéster
2% Lycra, 205 gr/m2

Tallas: De la 34 a la 58

Colores disponibles:



- Forrada
- Sin cinturilla
- Sin bolsillos
- Cierre Cremallera invisible
- Una abertura trasera

FALDA Sin Bolsillos

Sarga Lana
Señora

Mod. 40426170
Serie 6170
Tejido Legend

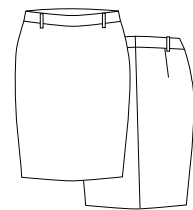

Composición:
45% lana
55% Poliéster,
190 gr/m2

Tallas: De la 34 a la 58

Colores disponibles:



- Forrada
- Con cinturilla y trabillas
- Cierre cremallera invisible
- Una abertura trasera
- Sin bolsillos

FALDA PANTALÓN

Abertura en lateral
con cremallera
en costado
Señora

Mod. 41032011
Serie: 2011
Tejido: Plácido

Tallas:
De la 34 a 58

Composición:
77% Poliéster
20% Viscosa
3% Elastómero
185 gr/m2

Colores:



VESTIDO Sin Mangas

Poliéster Elástico
Señora

Mod. V0036173
Serie 6173
Tejido Cómodo

.....

- ▶ Sin mangas
- ▶ Vestido entallado

Composición:
94% Poliéster,
6% Spandex
215 gr/m²

Tallas: De la 36 a la 50

Colores disponibles:



99
Negro

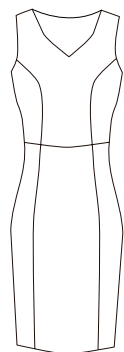

VESTIDO Manga Francesa

Poliéster Elástico
Señora

Mod. V0056173
Serie 6173
Tejido Cómodo

.....

- ▶ Manga tres cuartos
- ▶ Vestido entallado

Composición:
94% Poliéster,
6% Spandex
215 gr/m²

Tallas: De la 34 a la 50

Colores disponibles:



99
Negro

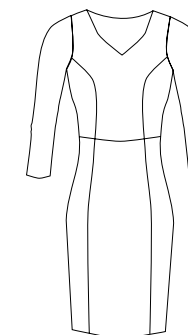

Complementos



Mod. 654/00
.....



Mod. 661/00
.....



Mod. 662/00
.....



Corbata lisa
Mod. 660/00
- Pala de siete cms.



Mod. 660/00
.....

Corbata con nudo
Mod. 661/00
- Pala de siete cms.
- Sólo en color negro

Lazo
Mod. 662/00
- Sólo en color negro

Pañuelo señora gasa
Mod. 654/00

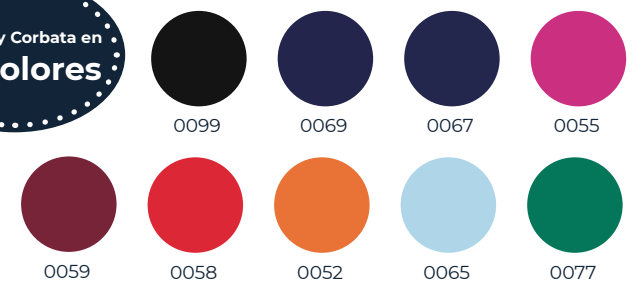



Mod. 697/00
.....



Mod. 687/00
.....



Mod. 686/00
.....



Mod. 693/00
.....



Mod. 683/00
.....

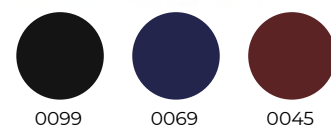

Cinturón caballero

Mod. 683/00

- Piel reciclada

Tallas:

90cm (M) / 100cm (L) / 110cm (XL)

Cinturón señora

Mod. 693/00

- Piel reciclada

Tallas:

80cm (M) / 90cm (L) / 100cm (XL)

Cinturón caballero

Mod. 687/00

- Piel vacuno

- Reversible

Tallas:

90cm (M) / 100cm (L) / 110cm (XL)

Cinturón señora

Mod. 697/00

□ Piel vacuno

Tallas:

80cm (M) / 90cm (L) / 100cm (XL)

Cinturón caballero

Mod. 686/00

- Hebilla personalizada

Tallas:

90cm (M) / 100cm (L) / 110cm (XL)



ESCAPARATE

Camisas Y Blusas

Cuello MAO



Gregario
3116 / 3116C

Libis
3616 / 3616C

65% Poliéster
35% Algodón



Monzón
3106 / 3106C

Tramontana
3610 / 3610C

65% Poliéster
35% Algodón

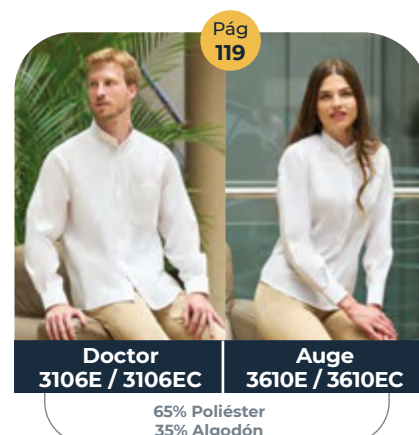

Doctor
3106E / 3106EC

Auge
3610E / 3610EC

65% Poliéster
35% Algodón

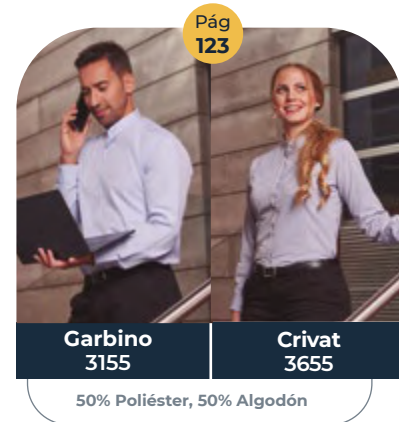

Garbino
3155

Crivat
3655

50% Poliéster, 50% Algodón



Marero
3156

Morella
3656

100% Algodón

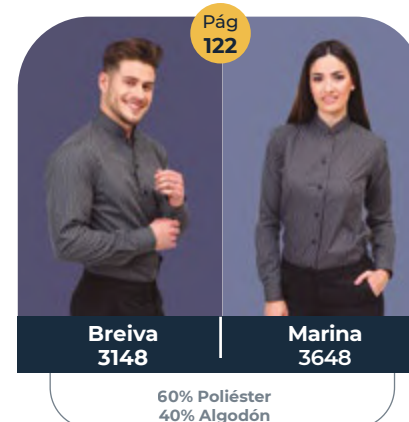

Breiva
3148

Marina
3648

60% Poliéster
40% Algodón

MANGA CORTA

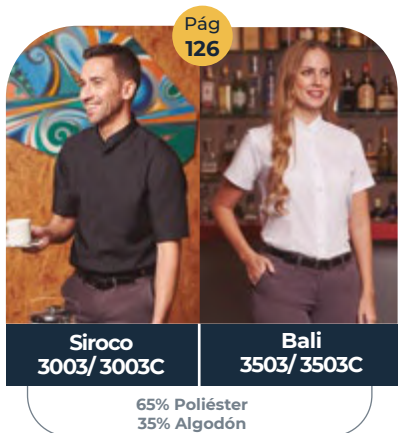

Siroco
3003 / 3003C

Bali
3503 / 3503C

65% Poliéster
35% Algodón



Pampero
3003e / 3003eC

Sumatra
3503e / 3503eC

65% Poliéster
35% Algodón



Llanes
3216 / 3216C

Luarca
3716 / 3716C

65% Poliéster
35% Algodón

Cuello CAMISERO



Pág
132

Biso
3145 / 3145C

65% Poliéster
35% Algodón



Pág
133

Coronel
3145E / 3145EC

65% Poliéster
35% Algodón



Pág
130

Cierzo
3101 / 3102 / 3102C

65% Poliéster
35% Algodón

Galerna
3601 / 3602 / 3602C

65% Poliéster
35% Algodón



Pág
131

Diablo
3101E / 3102E

65% Poliéster
35% Algodón

Vendaval
3601E / 3602E

65% Poliéster
35% Algodón

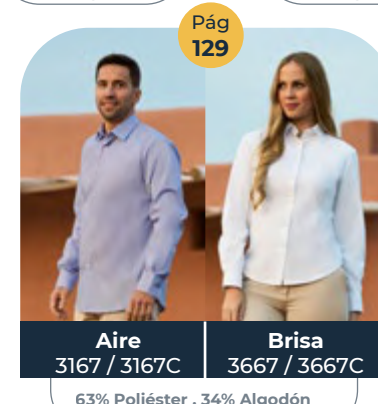

Pág
129

Aire
3167 / 3167C

63% Poliéster, 34% Algodón
3% Spandex

Brisa
3667 / 3667C

63% Poliéster, 34% Algodón
3% Spandex

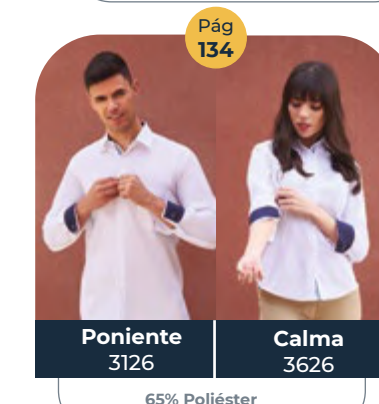

Pág
134

Poniente
3126

65% Poliéster
35% Algodón

Calma
3626

65% Poliéster
35% Algodón



Pág
136

Lebeche
3149

60% Algodón
40% Poliéster

Xaloc
3649

60% Algodón
40% Poliéster

MANGA CORTA



Pág
135

Barat
3166 / 3166C

60% Poliéster
40% Algodón

Ibe
3666 / 3666C

60% Poliéster
40% Algodón



Pág
137

Cirrus
3140

100% Algodón

Stratus
3640

100% Algodón

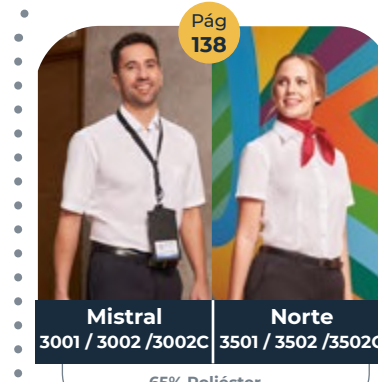

Pág
138

Mistral
3001 / 3002 / 3002C

65% Poliéster
35% Algodón

Norte
3501 / 3502 / 3502C

65% Poliéster
35% Algodón



Pág
139

Clod
3001E / 3002E

65% Poliéster
35% Algodón

Fuga
3501E / 3502E

65% Poliéster
35% Algodón

Blusas ESPECIALES

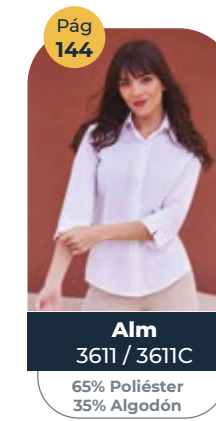

Pág
144

Alm
3611 / 3611C

65% Poliéster
35% Algodón

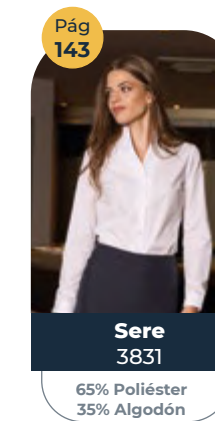

Pág
143

Sere
3831

65% Poliéster
35% Algodón



Pág
142

Medina
3806

65% Poliéster
35% Algodón

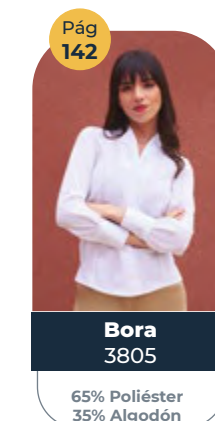

Pág
142

Bora
3805

65% Poliéster
35% Algodón

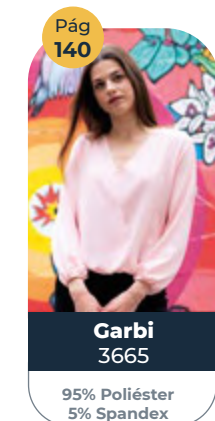

Pág
140

Garbi
3665

95% Poliéster
5% Spandex

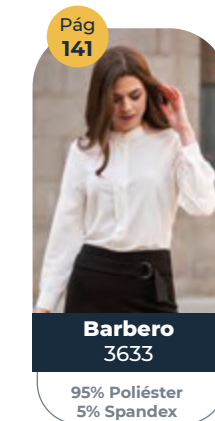

Pág
141

Barbero
3633

95% Poliéster
5% Spandex



Blusa

Cuello Mao
Manga Larga
Señora



Mod. Libis
Código 3616 Blanco
Código 3616C Negro y beig

Composición:
65% Poliéster
35% Algodón
116 gr/m²

- ▶ Botonadura Oculta
- ▶ Manga larga
- ▶ Cuello mao
- ▶ Pinzas espalda
- ▶ Pinzas delantero

Tallas: De la 34 a la 50

Colores disponibles:



Camisa

Cuello Mao
Manga Larga
Caballero



Mod. Gregario
Cód. 3116 Blanco
Cód. 3116C Negro y beig

Composición:
65% Poliéster
35% Algodón
116 gr/m²

- ▶ Botonadura Oculta
- ▶ Manga larga
- ▶ Cuello mao

Tallas: De la 1 a la 8

Colores disponibles:





Blusa

Cuello Mao
Manga larga
Señora



Mod. Tramontana
Código 3610 Blanco
Código 3610C Negro

Composición:
65% Poliéster
35% Algodón
116 gr/m²

- ▶ Manga larga
- ▶ Cuello mao
- ▶ Botón en puño
- ▶ Pinzas espalda
- ▶ Pinzas delantero

Tallas: De la 34 a la 58

Colores disponibles:



Camisa

Cuello Mao
Manga larga
Caballero



Mod. Monzón
Cód. 3106 Blanco
Cód. 3106C Negro

Composición:
65% Poliéster
35% Algodón
116 gr/m²

- ▶ Manga larga
- ▶ Cuello mao
- ▶ Botón en puño
- ▶ Dos pinzas espalda
- ▶ Con un bolsillo

Tallas: De la 1 a la 10

Colores disponibles:



Blusa

Cuello Mao
Manga larga
Señora

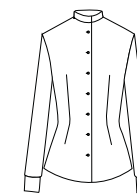

Mod. Auge
Código 3610E Blanco
Código 3610EC Negro

Composición:
65% Poliéster
35% Algodón
116 gr/m²

- ▶ Manga larga
- ▶ Cuello mao
- ▶ Botón en puño
- ▶ Pinzas espalda
- ▶ Pinzas delantero

Tallas: De la 34 a la 58

Colores disponibles:



Camisa

Cuello Mao
Manga larga
Caballero



Mod. Doctor
Cód. 3106E Blanco
Cód. 3106EC Negro

Composición:
65% Poliéster
35% Algodón
116 gr/m²

- ▶ Manga larga
- ▶ Cuello mao
- ▶ Botón en puño
- ▶ Dos pinzas espalda
- ▶ Con un bolsillo

Tallas: De la 1 a la 10

Colores disponibles:





Blusa

Cuello Mao
Imitación lino
Manga larga
Señora

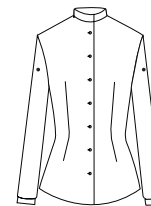

Mod. Morella
Código 3656

Composición:
100% Algodón
106 gr/m²

Tallas: De la 34 a la 50

Colores disponibles:



0000
Blanco

- ▶ Manga larga
- ▶ Tejido Imitación lino
- ▶ Cuello tirilla
- ▶ Puño 5 cm
- ▶ Botón imitación madera
- ▶ Trabilla recogemangas
- ▶ Bolsillo para coser

Camisa

Cuello Mao
Imitación lino
Manga larga
Caballero



Mod. Marero
Código 3156

Composición:
100% Algodón
106 gr/m²

Tallas: De la 34 a la 50

Colores disponibles:



0000
Blanco

- ▶ Manga larga
- ▶ Tejido Imitación lino
- ▶ Cuello tirilla
- ▶ Puño 5 cm
- ▶ Botón imitación madera
- ▶ Trabilla recogemangas
- ▶ Bolsillo para coser
- ▶ Semientallada



Camisa Rayas

Cuello Camisero
Manga Larga
Caballero

Mod. Breiva
Cód. 3148

Composición:
60% Poliéster
40% Algodón
89 gr/m²

- ▶ Manga larga
- ▶ Tejido Rayas
- ▶ Cuello Mao
- ▶ Botón en puño
- ▶ Bolsillo para coser
- ▶ Sementallada

Tallas: De la 1 a la 9

Colores disponibles:



0017 Gris



Blusa Rayas

Cuello Camisero
Manga Larga
Señora

Mod. Marina
Cód. 3648

Composición:
60% Poliéster
40% Algodón
89 gr/m²

- ▶ Manga larga
- ▶ Tejido Rayas
- ▶ Cuello Mao
- ▶ Botón en puño
- ▶ Bolsillo para coser

Tallas: De la 34 a la 50

Colores disponibles:

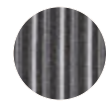

0017 Gris



Camisa Rayas al Tono

Cuello Mao
Manga larga
Caballero

Mod. Garbino
Cód. 3155

Composición:
50% Poliéster
50% Algodón
108 gr/m²

- ▶ Manga larga
- ▶ Tejido Rayas Finas
- ▶ Cuello tirilla
- ▶ Botón en puño
- ▶ Bolsillo para coser
- ▶ Sementallada

Tallas: De la 1 a la 8

Colores disponibles:



0000 Blanco
0006 Gris Claro
0061 Celeste



Blusa Rayas al Tono

Cuello Mao
Manga larga
Señora

Mod. Crivat
Código 3655

Composición:
50% Poliéster
50% Algodón
108 gr/m²

- ▶ Manga larga
- ▶ Tejido Rayas Finas
- ▶ Cuello tirilla
- ▶ Botón en puño
- ▶ Bolsillo para coser

Tallas: De la 34 a la 50

Colores disponibles:



0000 Blanco
0006 Gris Claro
0061 Celeste

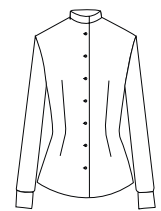



Blusa

Cuello Mao
Manga 3/4 con puño y abertura
Señora



Mod. Luarca
Código 3716 Blanco
Código 3716C Negro y beig

Composición:
65% Poliéster
35% Algodón
116 gr/m²

- ▶ Botonadura Oculta
- ▶ Manga 3/4
- ▶ Cuello mao
- ▶ Pinzas espalda
- ▶ Pinzas delantero

Tallas: De la 34 a la 50

Colores disponibles:



Camisa

Cuello Mao
Manga corta
Caballero



Mod. Llanes
Cód. 3216 Blanco
Cód. 3216C Negro y beig

Composición:
65% Poliéster
35% Algodón
116 gr/m²

- ▶ Botonadura Oculta
- ▶ Manga corta
- ▶ Cuello mao

Tallas: De la 1 a la 8

Colores disponibles:





Blusa

Cuello Mao
Manga corta
Señora

Mod. Bali
Código 3503 Blanco
Código 3503C Negro

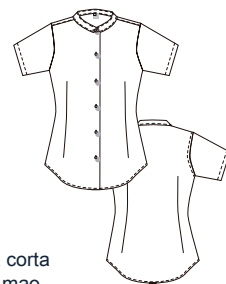

Composición:
65% Poliéster
35% Algodón
116 gr/m²

- ▶ Manga corta
- ▶ Cuello mao
- ▶ Pinzas espalda
- ▶ Pinzas delantero

Tallas: De la 36 a la 58

Colores disponibles:



Camisa

Cuello Mao
Manga corta
Caballero

Mod. Siroco
Cód. 3003 Blanco
Cód. 3003C Negro



Composición:
65% Poliéster
35% Algodón
116 gr/m²

- ▶ Manga corta
- ▶ Cuello mao
- ▶ Dos pinzas espalda
- ▶ Con un bolsillo

Tallas: De la 1 a la 10

Colores disponibles:



Camisa

Cuello Mao
Manga corta
Caballero

Mod. Pampero
Cód. 3003E Blanco
Cód. 3003EC Negro



Composición:
65% Poliéster
35% Algodón
116 gr/m²

- ▶ Manga corta
- ▶ Cuello mao
- ▶ Dos pinzas espalda
- ▶ Con un bolsillo

Tallas: De la 1 a la 10

Colores disponibles:



Blusa

Cuello Mao
Manga corta
Señora

Mod. Sumatra
Código 3503E Blanco
Código 3503EC Negro



Composición:
65% Poliéster
35% Algodón
116 gr/m²

- ▶ Manga corta
- ▶ Cuello mao
- ▶ Pinzas espalda
- ▶ Pinzas delantero

Tallas: De la 34 a la 58

Colores disponibles:

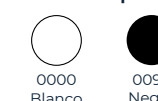



“Estirando los límites de la comodidad”



Camisa

Popelín Elástico
Manga larga
Caballero

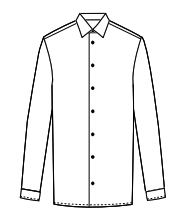

Mod. AIRE
Cód. 3167 Blanco
Cód. 3167C Negro y Celeste

Composición:
63% Poliéster
34% Algodón
3% Spandex
116 gr/m²

- ▶ Manga larga
- ▶ Cuello camisero
- ▶ Botón en puño

Tallas: De la 1 a la 10

Colores disponibles: 0000 Blanco 0099 Negro 0065 Celeste

Blusa

Popelín Elástico
Manga larga
Señora



Mod. BRISA
Código 3667 Blanco
Código 3667C Negro y Celeste

Composición:
63% Poliéster
34% Algodón
3% Spandex
116 gr/m²

- ▶ Manga larga
- ▶ Cuello camisero
- ▶ Botón en puño
- ▶ Pinzas espalda
- ▶ Pinzas delantero

Tallas: De la 34 a la 58

Colores disponibles: 0000 Blanco 0099 Negro 0065 Celeste



Camisa

Cuello Camisero Manga larga Caballero

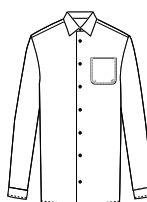

Mod. Cierzo
Cód. 3101 Blanco
Cód. 3102 Negro y Celeste
Cód. 3102C Gris, Royal y Chocolate

Composición:
65% Poliéster
35% Algodón
116 gr/m²

- ▶ Manga larga
- ▶ Cuello camisero
- ▶ Botón en puño
- ▶ Dos pinzas espalda
- ▶ Con un bolsillo

Tallas: De la 1 a la 10

Colores disponibles:

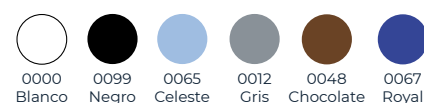

Blusa

Cuello Camisero Manga larga Señora



Mod. Galerna
Cód. 3601 Blanco
Cód. 3602 Negro y Celeste
Cód. 3602C Gris, Royal y Chocolate

Composición:
65% Poliéster
35% Algodón
116 gr/m²

- ▶ Manga larga
- ▶ Cuello camisero
- ▶ Botón en puño
- ▶ Pinzas espalda
- ▶ Pinzas delantero

Tallas: De la 34 a la 58

Colores disponibles:

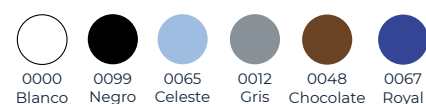

Camisa

Cuello Camisero Manga larga Caballero

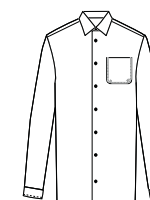

Mod. Diablo
Cód. 3101E Blanco
Cód. 3102E Negro y Celeste

Composición:
65% Poliéster
35% Algodón
116 gr/m²

- ▶ Manga larga
- ▶ Cuello camisero
- ▶ Botón en puño
- ▶ Dos pinzas espalda
- ▶ Con un bolsillo

Tallas: De la 1 a la 10

Colores disponibles:

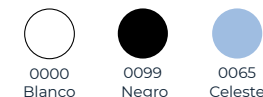

Blusa

Cuello Camisero Manga larga Señora



Mod. Vendaval
Cód. 3601E Blanco
Cód. 3602EC Negro y Celeste

Composición:
65% Poliéster
35% Algodón
116 gr/m²

- ▶ Manga larga
- ▶ Cuello camisero
- ▶ Botón en puño
- ▶ Pinzas espalda
- ▶ Pinzas delantero

Tallas: De la 34 a la 58

Colores disponibles:

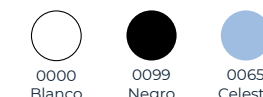



Camisa Semientallada Cuello Camisero Manga larga Caballero

Mod. Biso
Cód. 3145 Blanco
Cód. 3145C Negro

- ▶ Semientallada
- ▶ Manga larga
- ▶ Cuello camisero
- ▶ Botón en puño
- ▶ Pinzas espalda
- ▶ Ojales para gemelos

Composición:
65% Poliéster
35% Algodón
116 gr/m²

Tallas: De la 1 a la 10

Colores disponibles:

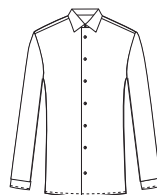

Camisa Semientallada Cuello Camisero Manga larga Caballero

Mod. Coronel
Cód. 3145E Blanco
Cód. 3145EC Negro

- ▶ Semientallada
- ▶ Manga larga
- ▶ Cuello camisero
- ▶ Botón en puño
- ▶ Pinzas espalda
- ▶ Ojales para gemelos

Composición:
65% Poliéster
35% Algodón
116 gr/m²

Tallas: De la 1 a la 10

Colores disponibles:

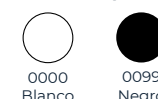



Camisa Combinada

Cuello Camisero
Manga larga
Caballero

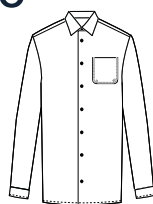

Mod. Poniente
Código 3126

Composición:
65% Poliéster
35% Algodón
116 gr/m²

- ▶ Manga larga
- ▶ Combinada con tejido popelín azul marino
- ▶ Cuello camisero
- ▶ Botón en puño
- ▶ Un bolsillo en pecho

Tallas: De la 1 a la 9

Colores disponibles:



0000
Blanco



Camisa Combinada

Cuello Camisero
Manga larga
Señora

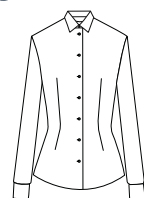

Mod. Calma
Código 3626

Composición:
65% Poliéster
35% Algodón
116 gr/m²

- ▶ Manga larga
- ▶ Combinada con tejido popelín azul marino
- ▶ Cuello camisero
- ▶ Botón en puño

Tallas: De la 36 a la 58

Colores disponibles:



0000
Blanco



Camisa fil a fil

Cuello Camisero
Tapeta de pellizco
Manga larga
Caballero



Mod. Barat
Cód. 3166 Blanco
Cód. 3166C Celeste

Composición:
60% Algodón
40% Poliéster
108 gr/m²

- ▶ Manga larga
- ▶ Cuello camisero
- ▶ Botón en puño
- ▶ Tapeta de pellizco

Tallas: De la 1 a la 8

Colores disponibles:



0000
Blanco



0065
Celeste



Adversia
Premium

Blusa fil a fil

Cuello Camisero
Tapeta de pellizco
Manga larga
Señora

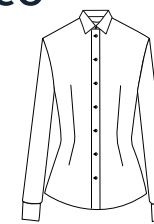

Mod. Ibe
Código 3666 Blanco
Código 3666C Celeste

Composición:
60% Algodón
40% Poliéster
108 gr/m²

- ▶ Manga larga
- ▶ Cuello camisero
- ▶ Botón en puño
- ▶ Pinzas delantero
- ▶ Tapeta de pellizco

Tallas: De la 34 a la 50

Colores disponibles:



0000
Blanco



0065
Celeste





Camisa Raya kodak

Cuello Camisero
Manga larga
Caballero

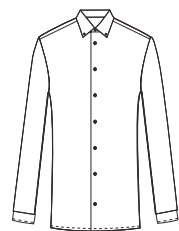

Mod. Lebeche
Código 3149

Composición:
60% Algodón
40% Poliéster
110 gr/m²

Tallas: De la 1 a la 8

Colores disponibles:



0061

- ▶ Manga larga
- ▶ Raya Kodak
- ▶ Cuello camisero
- ▶ Botón en puño
- ▶ Botón cuello
- ▶ Bolsillo para coser

Blusa Raya kodak

Cuello Camisero
Manga larga
Señora

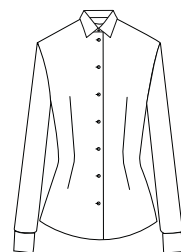

Mod. Xaloc
Código 3649

Composición:
60% Algodón
40% Poliéster
110 gr/m²

Tallas: De la 34 a la 50

Colores disponibles:

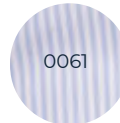

0061

- ▶ Manga larga
- ▶ Raya Kodak
- ▶ Cuello camisero
- ▶ Botón en puño
- ▶ Botón cuello
- ▶ Bolsillo para coser

Camisa Denim

Cuello Camisero
Manga larga
Caballero

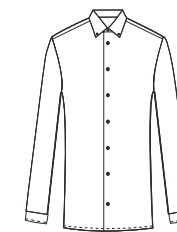

Mod. Cirrus
Código 3140

Composición:
100% Algodón
4,4 Oz (126 gr/m²)

Tallas: De la XS a la 3XL

Colores disponibles:

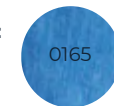

Lavado 5 años

- ▶ Botón en cuello
- ▶ Semientallada
- ▶ Tejido vaquero
- ▶ Dos pinzas espalda

Blusa Denim

Cuello Camisero
Manga larga
Señora

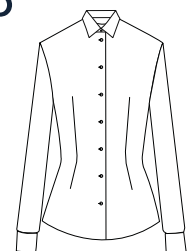

Mod. Stratus
Código 3640

Composición:
100% Algodón
4,4 Oz (126 gr/m²)

Tallas: De la 2XS a la 2XL

Colores disponibles:

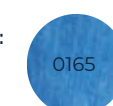

Lavado 5 años

- ▶ Tejido vaquero
- ▶ Dos pinzas espalda
- ▶ Dos pinzas delantero



Camisa

Cuello Camisero
Manga corta
Caballero

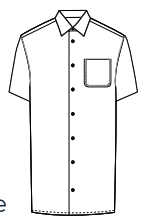

Mod. Mistral
Cód. 3001 Blanco
Cód. 3002 Negro y Celeste
Cód. 3002C Gris, Royal y Chocolate

Composición:
65% Poliéster
35% Algodón
116 gr/m²

- ▶ Manga corta
- ▶ Cuello Camisero
- ▶ Dos pinzas espalda
- ▶ Con un bolsillo

Tallas: De la 1 a la 10

Colores disponibles:



Blusa

Cuello Camisero
Manga corta
Señora



Mod. Norte
Cód. 3501 Blanco
Cód. 3502 Negro y Celeste
Cód. 3502C Gris, Royal y Chocolate

Composición:
65% Poliéster
35% Algodón
116 gr/m²

- ▶ Manga corta
- ▶ Cuello Camisero
- ▶ Pinzas espalda
- ▶ Pinzas delantero

Tallas: De la 34 a la 58

Colores disponibles:



Camisa

Cuello Camisero
Manga corta
Caballero

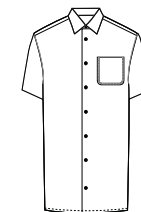

Mod. Clod
Cód. 3001E Blanco
Cód. 3002EC Negro y Celeste

Composición:
65% Poliéster
35% Algodón
116 gr/m²

- ▶ Manga corta
- ▶ Cuello Camisero
- ▶ Dos pinzas espalda
- ▶ Con un bolsillo

Tallas: De la 1 a la 10

Colores disponibles:



Blusa

Cuello Camisero
Manga corta
Señora



Mod. Fuga
Código 3501E Blanco
Código 3502E Negro y Celeste

Composición:
65% Poliéster
35% Algodón
116 gr/m²

- ▶ Manga corta
- ▶ Cuello Camisero
- ▶ Pinzas espalda
- ▶ Pinzas delantero

Tallas: De la 34 a la 58

Colores disponibles:





Adversia
Premium

Blusa Abullonada con goma en puño y bajo cruzada delantero y fruncido hombro Señora

Mod. Garbi
Código 3665

Tallas:
De la 34 a la 50

Composición:
95% Poliéster
5% Spandex
160 gr/m2

Colores:



Adversia
Premium

Blusa Crepé Cuello Mao Canesú Espalda Señora

Mod. Barbero
Código 3633

Tallas:
De la 34 a la 50

Composición:
95% Poliéster
5% Spandex
160 gr/m2

Colores:

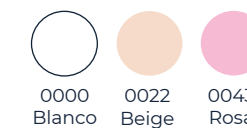



Blusa Semientallada Cuello Abierto Manga larga Señora



Mod. Medina
Código 3806

Composición:
65% Poliéster
35% Algodón
116 gr/m²

- ▶ Manga larga
- ▶ Pinza delantera
- ▶ Cuello camisero abierto

Tallas: De la 36 a la 48

Colores disponibles:



Blusa Semientallada Cuello Chimenea Manga larga Señora



Mod. Bora
Código 3805

Composición:
65% Poliéster
35% Algodón
116 gr/m²

- ▶ Cuello chimenea
- ▶ Manga larga
- ▶ Dos pinzas delanteras
- ▶ Botonadura interior, botones ocultos

Tallas: De la 36 a la 48

Colores disponibles:



Blusa Semientallada Cuello Tulipán Manga Larga Señora

Mod. Sere
Código 3831

- ▶ Manga larga
- ▶ Pinza delantera
- ▶ Cuello Tulipán
- ▶ Puño 5cm

Composición:
65% Poliéster
35% Algodón
116 gr/m²

Tallas: De la 34 a la 50

Colores disponibles:

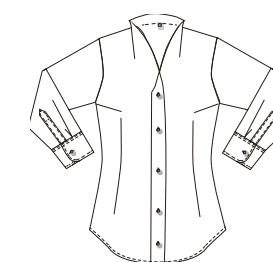



Blusa Entallada Cuello Camisero Manga Francesa Señora

Mod. Alm
Código 3611 Blanco
Código 3611C Negro

.....

- ▶ Manga francesa con abertura
- ▶ Tejido popelín
- ▶ Cuello camisero
- ▶ Pinzas espalda
- ▶ Pinzas delantero

Composición:
65% Poliéster
35% Algodón
116 gr/m²

Tallas: De la 34 a la 58

Colores disponibles:



0000
Blanco



0099
Negro

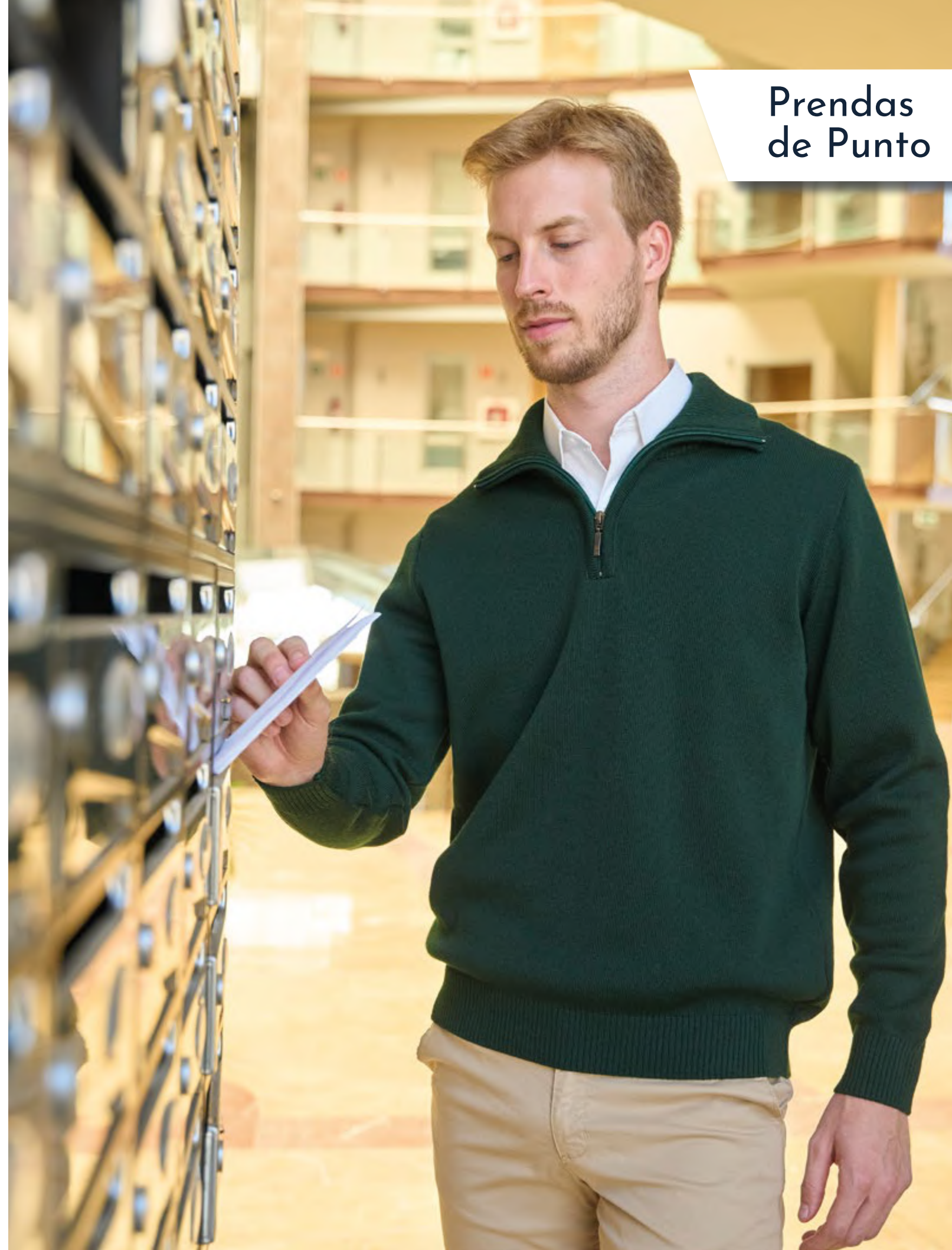

Prendas
de Punto

ESCAPARATE

Prendas de Punto

Jerseys

<p>Pág 147</p>  <p>Chile 4319</p> <p>50% Lana Merino 50% Acrílico</p>	<p>Pág 148</p>  <p>Báltico 4101</p> <p>50% Lana Merino 50% Acrílico</p>	<p>Pág 148</p>  <p>Bering 4201</p> <p>100% Acrílico</p>	<p>Pág 149</p>  <p>Tasmania 4316</p> <p>100% Algodón</p>	<p>Pág 149</p>  <p>Salomón 4314</p> <p>50% Lana Virgen 50% Acrílico</p>	
<p>Pág 150</p>  <p>Cantábrico 4102</p> <p>50% Lana Merino 50% Acrílico</p>	<p>Pág 150</p>  <p>Egeo 4202</p> <p>100% Acrílico</p>	<p>Pág 151</p>  <p>Jonico 4317</p> <p>100% Algodón</p>	<p>Pág 151</p>  <p>Coral 4315</p> <p>50% Lana Virgen 50% Acrílico</p>	<p>Pág 152</p>  <p>Adriático 4310</p> <p>50% Lana Virgen 50% Acrílico</p>	<p>Pág 152</p>  <p>Bengala 4311</p> <p>50% Lana Virgen 50% Acrílico</p>

Chaquetas

<p>Pág 153</p>  <p>Irlanda 4313</p> <p>50% Lana Virgen 50% Acrílico</p>	<p>Pág 153</p>  <p>Aral 4312</p> <p>50% Lana Virgen 50% Acrílico</p>	<p>Pág 154</p>  <p>Labrador 4204</p> <p>100% Acrílico</p> <p>Antártida 4604</p> <p>100% Acrílico</p>	<p>Pág 155</p>  <p>Caspio 4104</p> <p>50% Lana Merino 50% Acrílico</p> <p>Baffin 4704</p> <p>50% Lana Merino 50% Acrílico</p>
---------------------------------------------------------------------------------------------------------------------------------------------------------------------------	------------------------------------------------------------------------------------------------------------------------------------------------------------------------	---------------------------------------------------------------------------------------------------------------------------------------------------------------------------------------------------------------	--------------------------------------------------------------------------------------------------------------------------------------------------------------------------------------------------------------------------------------------------

Chalecos

<p>Pág 156</p>  <p>Tirreno 4203</p> <p>100% Acrílico</p>	<p>Pág 156</p>  <p>Cortes 4103</p> <p>50% Lana Merino 50% Acrílico</p>	<p>Pág 157</p>  <p>Tirreno 4318</p> <p>50% Lana Virgen 50% Acrílico</p>
--------------------------------------------------------------------------------------------------------------------------------------------------------	--------------------------------------------------------------------------------------------------------------------------------------------------------------------------	----------------------------------------------------------------------------------------------------------------------------------------------------------------------------

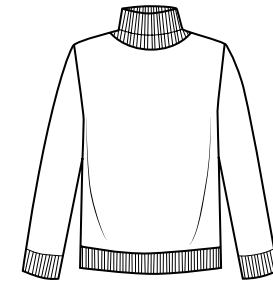

JERSEY

Cuello Cisne

Unisex

Mod. Chile
Código 4319

Composición:
50% Lana Merino
50% Acrílico

Tallas:
De la S a la 5XL

Colores:

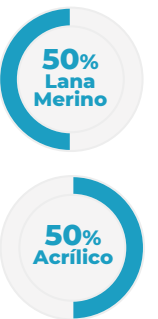
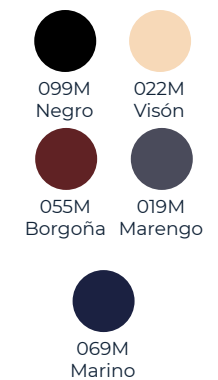



50% Lana Merino

50% Acrílico



100% Acrílico



100% Algodón



50% Lana Virgen

50% Acrílico

JERSEY Lana Acrílico Cuello Pico

Unisex

Mod. Báltico
Código 4101

Composición:
50% Lana Merino
50% Acrílico

Tallas: De la XS a la 4XL

Colores disponibles:

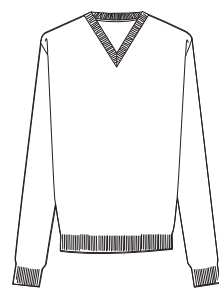
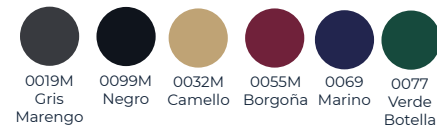

JERSEY Acrílico Cuello Pico

Unisex

Mod. Bering
Código 4201

Composición:
100% Acrílico

Tallas: De la S a la 5XL

Colores disponibles:

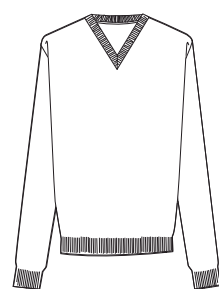
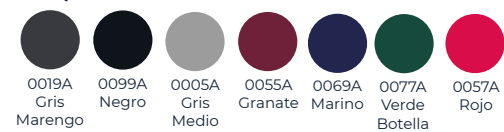

JERSEY Algodón Cuello Pico

Unisex

Mod. Tasmania
Código 4316

Composición:
100% Algodón

Tallas: De la S a la 5XL

Colores disponibles:

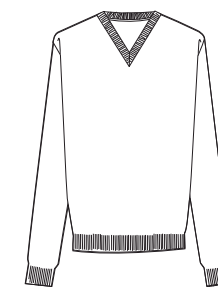
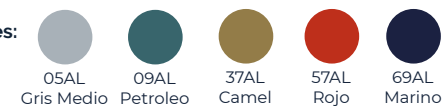

JERSEY Cerrojillo Cuello Pico

Unisex

Mod. Salomón
Código 4314

Composición:
50% Lana Virgen
50% Acrílico

Tallas: De la S a la 5XL

Colores disponibles:

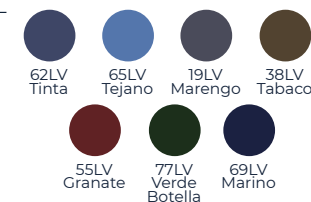



50% Lana Merino

50% Acrílico



100% Acrílico



100% Algodón



50% Lana Virgen

50% Acrílico

JERSEY Lana Acrílico

Cuello Caja

Unisex

Mod. Cantábrico
Código 4102

Composición:
50% Lana Merino
50% Acrílico

Tallas: De la XS a la 4XL

Colores disponibles:

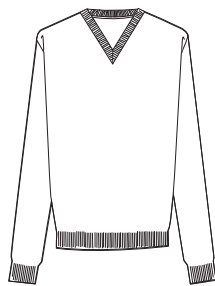
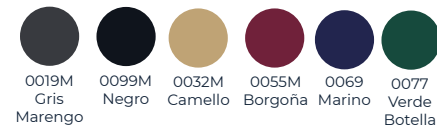

JERSEY Acrílico

Cuello Caja

Unisex

Mod. Egeo
Código 4202

Composición:
100% Acrílico

Tallas: De la S a la 5XL

Colores disponibles:

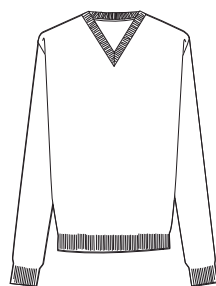
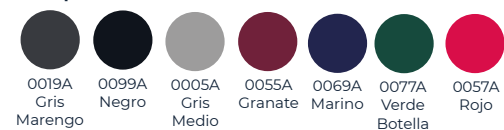

JERSEY Algodón

Cuello Caja

Unisex

Mod. Jonico
Código 4317

Composición:
100% Algodón

Tallas: De la S a la 5XL

Colores disponibles:

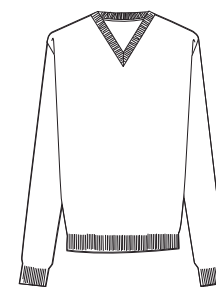
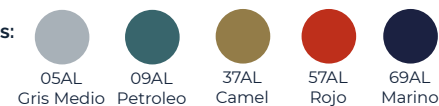

JERSEY Cerrojillo

Cuello Caja

Unisex

Mod. Coral
Código 4315

Composición:
50% Lana Virgen
50% Acrílico

Tallas: De la S a la 5XL

Colores disponibles:

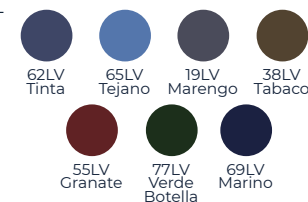



SUÉTER Combinado Cuello Semicisne

Unisex

Mod. Adriático
Código 4310

Composición:
50% Lana Virgen
50% Acrílico

Tallas: De la S a la 5XL

Colores disponibles:

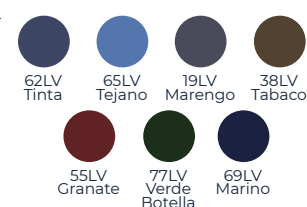

SUÉTER Liso Cuello Semicisne

Unisex

Mod. Bengala
Código 4311

Composición:
50% Lana Virgen
50% Acrílico

Tallas: De la S a la 5XL

Colores disponibles:

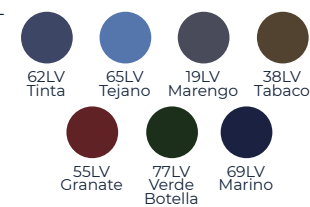

CHAQUETA Liso Cuello Semicisne

Unisex

Mod. Irlanda
Código 4313

Composición:
50% Lana Virgen
50% Acrílico

Tallas: De la S a la 5XL

Colores disponibles:

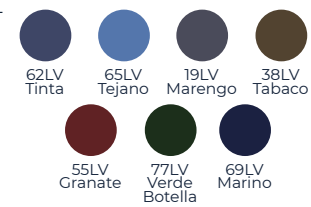

CHAQUETA Combinado Cuello Semicisne

Unisex

Mod. Aral
Código 4312

Composición:
50% Lana Virgen
50% Acrílico

Tallas: De la S a la 5XL

Colores disponibles:

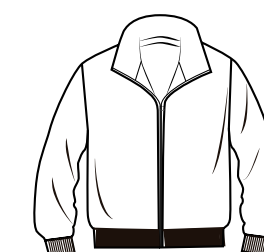
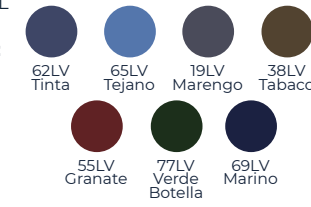



100% Acrílico



50% Lana Merino

50% Acrílico



CHAQUETA Acrílico Cuello Pico Caballero

Mod. Labrador
Código 4204

Composición:
100% Acrílico

Tallas: De la S a la 5XL

Colores disponibles:

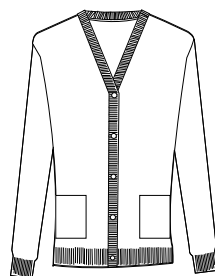
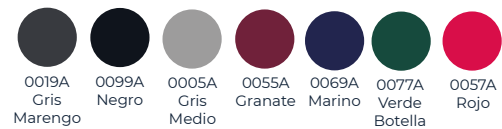

CHAQUETA Acrílico Cuello Pico Señora

Mod. Antártida
Código 4604

Composición:
100% Acrílico

Tallas: De la S a la 5XL

Colores disponibles:

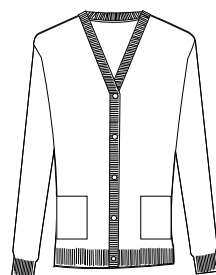
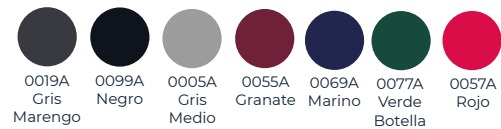

CHAQUETA Lana Acrílico Cuello Pico Caballero

Mod. Caspio
Código 4104

Composición:
50% Lana Merino
50% Acrílico

Tallas: De la XS a la 4XL

Colores disponibles:

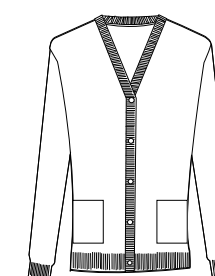
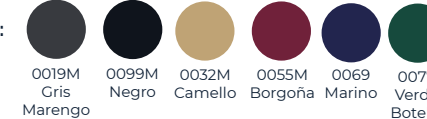

CHAQUETA Lana Acrílico Cuello Pico Señora

Mod. Baffin
Código 4704

Composición:
50% Lana Merino
50% Acrílico

Tallas: De la XS a la 2XL

Colores disponibles:

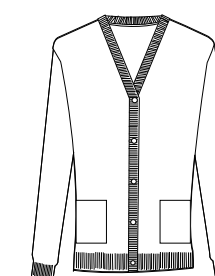
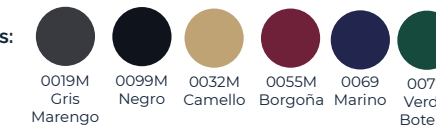



CHALECO Acrílico Cuello Pico Unisex

Mod. Tirreno
Código 4203

Composición:
100% Acrílico

Tallas: De la S a la 5XL

Colores disponibles:

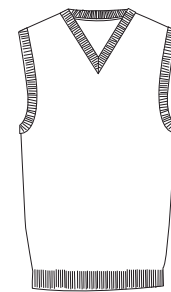
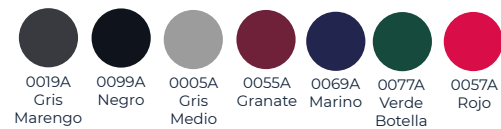

CHALECO Lana Acrílico Cuello Pico Unisex

Mod. Cortes
Código 4103

Composición:
50% Lana Merino
50% Acrílico

Tallas: De la XS a la 4XL

Colores disponibles:

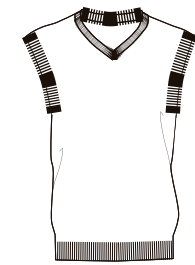
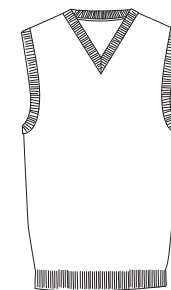
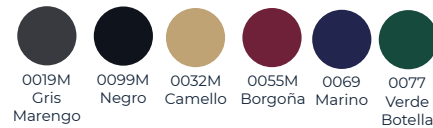

CHALECO Sin Mangas Cuello Pico Con Vivos

Unisex

Mod. Tireno
Código 4318

Composición:
50% Lana Virgen
50% Acrílico

Tallas:
De la S a la 5XL

Colores:



ESCAPARATE

Chaquetas de Cocina

Manga Larga



Manga Larga

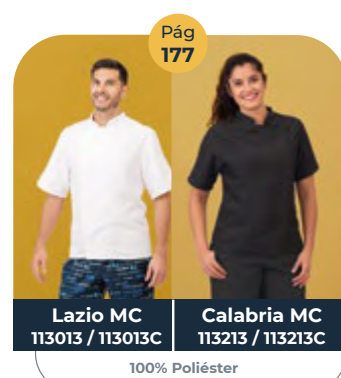



Chaqueta Microfibra

Broches Ocultos,
Nido de abeja
en los costados

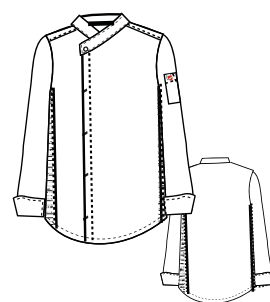

Caballero
Mod. Bolzano
Cód. 113019 Blanco
Cód. 113019C Colores

Tallas:
De la XS a la 3XL

Composición:
100% Poliéster
145 gr/m²

Nido de abeja:
100% poliéster
130 gr/m²

Colores:



Señora
Mod. Catania
Cód. 113219 Blanco
Cód. 113219C Colores

Tallas:
De la XS a la 2XL

Composición:
100% Poliéster
145gr/m²

Nido de abeja:
100% poliéster
130 gr/m²

Colores:

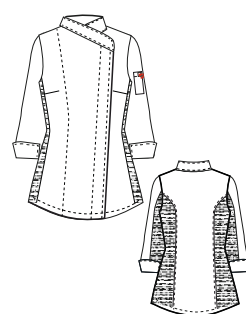
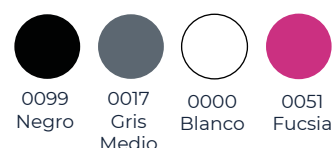

Chaqueta Microfibra

Espalda Transpirable



Caballero
Mod. Lazio
Cód. 113012 Blanco
Cód. 113012C Colores

Tallas:
De la S a la 4XL

Composición:
100% Poliéster
145 gr/m²

Nido de abeja:
100% poliéster
130 gr/m²

Colores:



Señora
Mod. Calabria
Cód. 113212 Blanco
Cód. 113212C Colores

Tallas:
De la XS a la 2XL

Composición:
100% Poliéster
145gr/m²

Nido de abeja:
100% poliéster
130 gr/m²

Colores:





Chaqueta con Poliéster Reciclado Microfibra

Caballero
Mod. Luca
Cód. 113050

Tallas:
De la XS a la 3XL

Composición:
44% Poliéster Reciclado
56% Poliéster Convencional
160gr/m²

Nido de abeja:
100% poliéster
125 gr/m²

Colores:

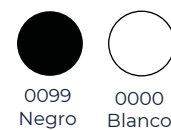

Señora
Mod. Ravena
Cód. 113250

Tallas:
De la 2XS a la 2XL

Composición:
44% Poliéster Reciclado
56% Poliéster Convencional
160gr/m²

Nido de abeja:
100% poliéster
125 gr/m²

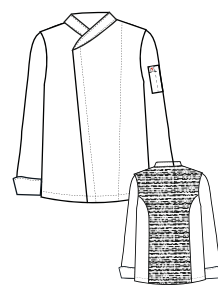
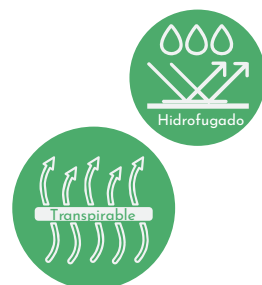
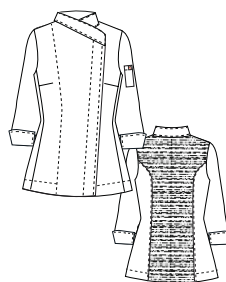

Chaqueta Entallada Popelín Vigoré y Nido de Abeja

Caballero
Mod. Cerdeña
Código 113022

Tallas:
De la XS a la 3XL

Composición:
65% Poliéster
35% Algodón
108 gr/m²

Nido de abeja:
100% poliéster
125 gr/m²

Colores:

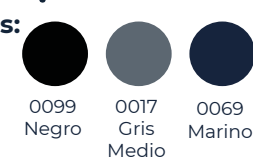

Señora
Mod. Brescia
Código 113222

Tallas:
De la XS a la 2XL

Composición:
65% Poliéster
35% Algodón
108 gr/m²

Nido de abeja:
100% poliéster
125 gr/m²





Chaqueta Transpirable

Automáticos ocultos

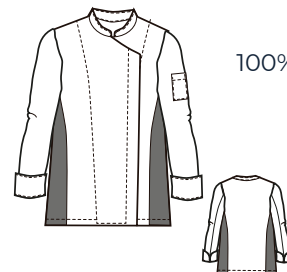

Caballero
Mod. Siena
Cód. 113008 Blanco
Cód. 113008C Colores

Tallas:
De la XS a la 4XL

Composición:
65% Poliéster
35% Algodón
195 gr/m²

Gesdry:
100% poliéster
125 gr/m²

Colores:



Señora
Mod. Sorrento
Cód. 113208 Blanco
Cód. 113208C Colores

Tallas:
De la XS a la 2XL

Composición:
65% Poliéster
35% Algodón
195 gr/m²

Gesdry:
100% poliéster
125 gr/m²

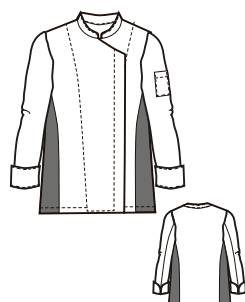

Chaqueta Espalda Gesdry+

Vivo con alma en Puño y cuello

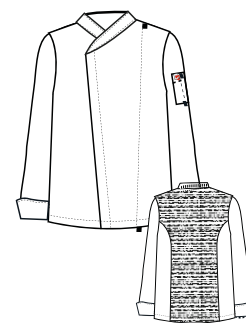

Caballero
Mod. Matera
Cód. 113018 Blanco
Cód. 113018C Colores

Tallas:
De la XS a la 3XL

Composición:
65% Poliéster
35% Algodón
195 gr/m²

Nido de abeja:
100% poliéster
125 gr/m²

Colores:



Señora
Mod. Siracusa
Cód. 113218 Blanco
Cód. 113218C Colores

Tallas:
De la XS a la 2XL

Composición:
65% Poliéster
35% Algodón
195 gr/m²

Nido de abeja:
100% poliéster
125 gr/m²

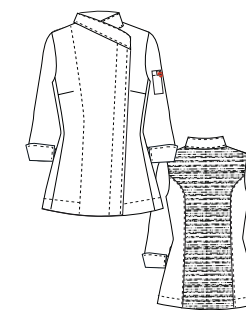



Chaqueta Espalda Gesdry+

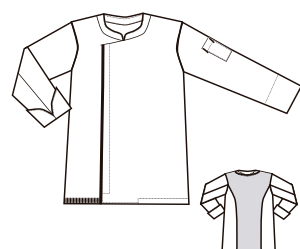

Caballero
Mod. Lombardia
 Cód. 113011 Blanco
 Cód. 113011C Colores

Tallas:
 De la S a la 5XL

Composición:
 65% Poliéster
 35% Algodón
 195 gr/m²

Gesdry:
 100% poliéster
 125 gr/m²

Colores:



Señora
Mod. Toscana
 Cód. 113211 Blanco
 Cód. 113211C Colores

Tallas:
 De la XS a la 2XL

Composición:
 65% Poliéster
 35% Algodón
 195 gr/m²

Gesdry:
 100% poliéster
 125 gr/m²



Chaqueta Cuello Mao

Tapeta botones ocultos,
 fuele en esalda

Unisex

Mod. Florencia

Código: 113010 Blanco

Código: 113010C Colores

Tallas:
 -XS a 4xl

Composición:
 65% Poliéster
 35% Algodón
 195 gr/m²

Colores:

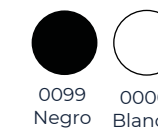

Chaqueta 10 botones

Unisex



Mod. Arezzo

Código: 113009 Blanco

Código: 113009C Colores

Tallas:

-XS a 4xl

Composición:

65% Poliéster
35% Algodón
195gr/m²

Colores:

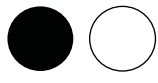

0099 Negro 0000 Blanco



Chaqueta Broches Ocultos

Nido de abeja en los costados



Caballero

Mod. Turín

Cód. 113021

Tallas:
De la XS a la 3XL

Composición:

55% Algodón
42% Poliéster
3% Elastano
182 gr/m²

Nido de abeja:
100% poliéster
130 gr/m²

Colores:

0000
Blanco

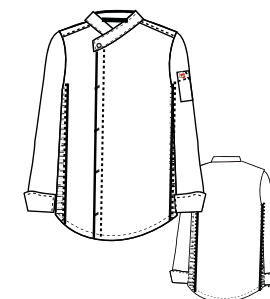

Señora

Mod. Mesina

Cód. 113221

Tallas:
De la XS a la 2XL

Composición:

55% Algodón
42% Poliéster
3% Elastano
182 gr/m²

Nido de abeja:
100% poliéster
130 gr/m²

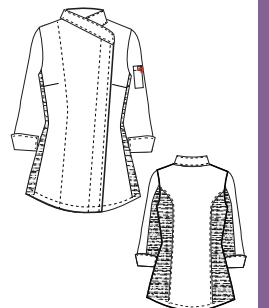



Chaqueta Vaquera Elástica



Caballero
Mod. Padua
Cód. 113001

Tallas:
De la XS a la 4XL

Composición:
98% Algodón
2% Elastano
6,5 Oz (220 gr/m²)

Colores:



0165
Denim



Señora
Mod. Módena
Cód. 113201

Tallas:
De la XS a la 2XL

Composición:
98% Algodón
2% Elastano
6,5 Oz (220 gr/m²)



Chaqueta Estilo Militar y Coderas Caballero



Mod. Andria
Código: 113015

Tallas:
-XS a 3xl

Composición:
59% Algodón
39% Poliéster
2% Elastómero
257 gr/m²

Colores:



0073
Verde
Caqui



Chaquetas Cocina

Manga Corta



Chaqueta Entallada Popelín Vigoré y Nido de Abeja

Caballero
Mod. Herculano
Código 113020

Tallas:
De la XS a la 3XL

Composición:
65% Poliéster
35% Algodón
108 gr/m²

Nido de abeja:
100% poliéster
125 gr/m²

Colores:

Señora
Mod. Modena
Código 113220

Tallas:
De la XS a la 2XL

Composición:
65% Poliéster
35% Algodón
108 gr/m²

Nido de abeja:
100% poliéster
125 gr/m²

Colores:

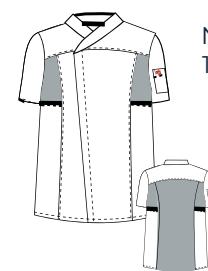

0099
Negro



0017
Gris
Medio



0069
Marino

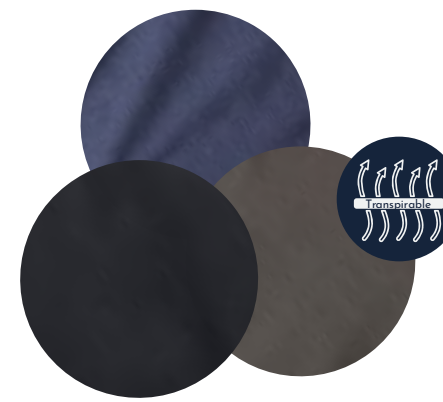



Chaqueta Espalda con nido de abeja

Vivo con alma en cuello



Caballero
Mod. Trento
Cód. 113017 Blanco
Cód. 113017C Colores

Tallas:
De la XS a la 3XL

Composición:
65% Poliéster
35% Algodón
195 gr/m²

Nido de abeja:
(Gesdry+)
100% poliéster
125 gr/m²

Colores:



Señora
Mod. Mesina
Cód. 113217 Blanco
Cód. 113217C Colores

Tallas:
De la XS a la 2XL

Composición:
65% Poliéster
35% Algodón
195 gr/m²

Nido de abeja:
(Gesdry+)
100% poliéster
125 gr/m²



Chaqueta Popelín m/c

Unisex



Mod. Novara

Código: 113005 Blanco
Código: 113005C Colores

Tallas:

-XS a 4xl

Composición:

65% Poliéster
35% Algodón
195gr/m²

Colores:



Chaqueta Microfibra

Espalda Transpirable



Caballero
Mod. Lazio MC
Cód. 113013 Blanco
Cód. 113013C Colores

Tallas:
De la S a la 4XL

Composición:
100% Poliéster
145 gr/m²

Nido de abeja:
100% poliéster
130 gr/m²

Colores:

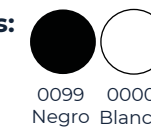

Señora
Mod. Calabria MC
Cód. 113213 Blanco
Cód. 113213C Colores

Tallas:
De la XS a la 2XL

Composición:
100% Poliéster
145 gr/m²

Nido de abeja:
100% poliéster
130 gr/m²

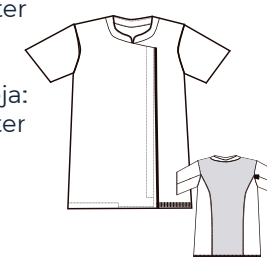



ESCAPARATE



Delantales y Casullas

Delantales Cortos



Delantales Cortos



Delantal Peto



ESCAPARATE

Delantales y Casullas

Delantales Peto

Delantal Peto Sarga

<p>Pág 199</p> <p>Lieja 110050 100% Algodón Orgánico</p>	<p>Pág 217</p> <p>Pau 110012 / 110012C 65% Poliéster 35% Algodón</p>	<p>Pág 216</p> <p>Dijon 110002 70% Poliéster 30% Algodón</p>	<p>Pág 218</p> <p>Grenoble 110005 65% Poliéster 35% Algodón</p>	<p>Pág 207</p> <p>Saona 110013 100% Algodón</p>	<p>Pág 215</p> <p>Boue 110009 / 110009C 65% Poliéster 35% Algodón</p>
-------------------------------------------------------------------------	-----------------------------------------------------------------------------------------	---------------------------------------------------------------------------------	------------------------------------------------------------------------------------	----------------------------------------------------------------	------------------------------------------------------------------------------------------

Delantal Peto Poliéster

<p>Pág 205</p> <p>Aquitania 110020 100% Acrílico Dralón</p>	<p>Pág 204</p> <p>Hatten 110018 100% Acrílico Dralón</p>	<p>Pág 208</p> <p>Creuse 110019 100% Poliéster</p>	<p>Pág 209</p> <p>Versalles 110015 100% Poliéster</p>	<p>Pág 213</p> <p>Sedan 110014 100% Poliéster</p>	<p>Pág 212</p> <p>Orange 110016 100% Poliéster</p>	<p>Pág 214</p> <p>Aix 110011 100% Poliéster</p>
----------------------------------------------------------------------------	-------------------------------------------------------------------------	-------------------------------------------------------------------	----------------------------------------------------------------------	------------------------------------------------------------------	-------------------------------------------------------------------	----------------------------------------------------------------

<p>Pág 200</p> <p>Carcasona 110028 100% Poliéster</p>	<p>Pág 202</p> <p>Anncy 110027 65% Poliéster 35% Algodón</p>	<p>Pág 203</p> <p>Colmar 110026 85% Algodón 15% Poliéster</p>	<p>Pág 210</p> <p>Rennes 110004 98% Algodón 2% Elastano</p>	<p>Pág 206</p> <p>Arras 110021 70% poliéster 26% algodón 4% elastán</p>
----------------------------------------------------------------------	---------------------------------------------------------------------------------	----------------------------------------------------------------------------------	--------------------------------------------------------------------------------	------------------------------------------------------------------------------------------------

Delantal Peto PVC

<p>Pág 225</p> <p>Paul 110024 100% PVC Plastificado</p>	<p>Pág 225</p> <p>Var 110023 64% PVC, 27% Poliéster 9% Algodón</p>	<p>Pág 225</p> <p>Marne 110022 91% PVC 9% Poliéster</p>
----------------------------------------------------------------------------	---------------------------------------------------------------------------------------	----------------------------------------------------------------------------

Delantales Medio

<p>Pág 219</p> <p>Nimes 110404 / 110404C 65% Poliéster 35% Algodón</p>	<p>Pág 210</p> <p>Reins 110403 98% Algodón 2% Elastano</p>	<p>Pág 201</p> <p>Dunkerque 110422 100% Poliéster</p>
-------------------------------------------------------------------------------------------	-------------------------------------------------------------------------------	----------------------------------------------------------------------

Delantales Cortos Sarga

<p>Pág 207</p> <p>Baume 110413 100% Algodón</p>	<p>Pág 216</p> <p>Valance 110411 70% Poliéster 30% Algodón</p>	<p>Pág 219</p> <p>Le Mans 110604 / 110604C 65% Poliéster 35% Algodón</p>
----------------------------------------------------------------	-----------------------------------------------------------------------------------	---------------------------------------------------------------------------------------------

Delantales Cortos Poliéster

<p>Pág 205</p> <p>Landas 110420 100% Acrílico Dralón</p>	<p>Pág 208</p> <p>Lot 110419 100% Poliéster</p>	<p>Pág 214</p> <p>Amiens 110412 100% Poliéster</p>
-------------------------------------------------------------------------	----------------------------------------------------------------	-------------------------------------------------------------------

Casullas

<p>Pág 206</p> <p>Carona 110421 70% poliéster 26% algodón 4% elastán</p>	<p>Pág 210</p> <p>Brest 110603 98% Algodón 2% Elastano</p>	<p>Pág 199</p> <p>Gason 110410 100% Algodón Orgánico</p>	<p>Pág 220</p> <p>París 110201 / 110201C 65% Poliéster 35% Algodón</p>	<p>Pág 221</p> <p>Bretaña 110804 / 110804C 100% Poliéster</p>	<p>Pág 221</p> <p>Loira 110803 / 110803C 65% Poliéster 35% Algodón</p>	<p>Pág 223</p> <p>Bayona 110805 65% Poliéster 35% Algodón</p>
-------------------------------------------------------------------------------------------------	-------------------------------------------------------------------------------	-----------------------------------------------------------------------------	-------------------------------------------------------------------------------------------	------------------------------------------------------------------------------	-------------------------------------------------------------------------------------------	----------------------------------------------------------------------------------



Delantal Corto

Bolsillo asimétrico
Hebilla decorativa

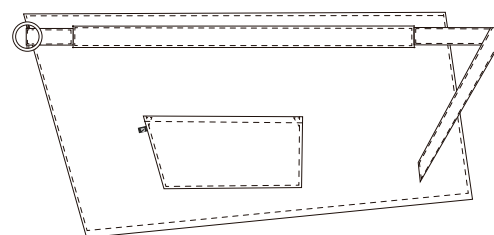

Mod. PIANA
Código 110605

Tallas: Única

Medidas: 85x40cm
Largo asimétrico
(parte corta 35cm)

Composición:
100% Poliéster
200gr/m2

Colores:

	
0077 Verde	0099 Negro

"Bolsillo negro"





Delantal Corto

Bolsillo oculto,
Superposiciones
Diseño elegante

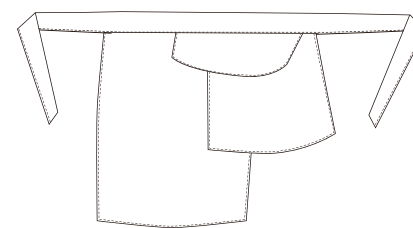

Mod. VITRE
Código 110607
Serie 2010

Tallas: Única

Medidas: 57x41cm
Pieza asimétrica(Largo 30cm)

Composición:
100% Poliéster
125gr/m2

Colores:



0099
Negro







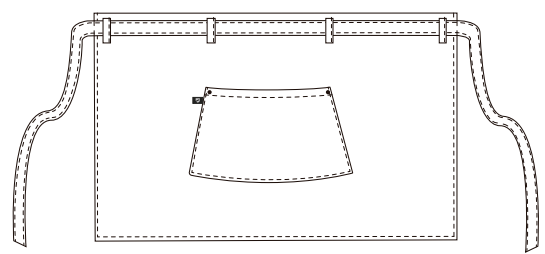

Delantal Medio

Bolsillos con remaches
Efecto cinturón

Mod. JOSSELIN
Código 110428
Tallas: Única
Medidas: 84x36cm
Composición:
100% Poliéster
200gr/m2



- Colores:**
-  7722 Verde
"Tira Beige" "Tira Verde"
 -  2277 Beige
 -  0022 Beige
 -  0099 Negro



Delantal Peto

Antiestrés cervical
Bolsillos con remaches

Mod. MINERVE
Código 110030

Tallas: Única

Medidas: 82x89cm

Composición:
100% Poliéster
200gr/m2

Colores:



0077
Verde
"Contraste
Beige"



5557
Beige
"Contraste
Granate"



0022
Beige



0099
Negro

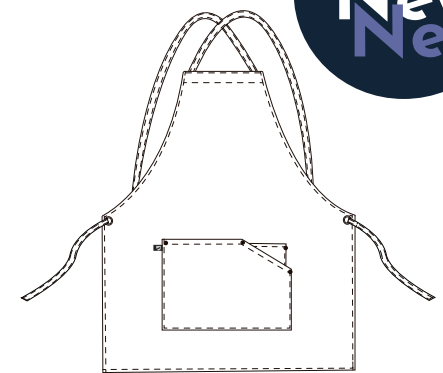



Delantal Medio

Bolsillos con remaches
Dos ollados

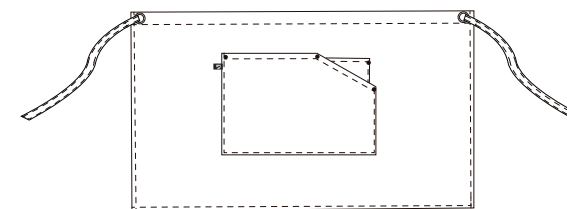

Mod. ROUSILLÓN

Código 110430

Tallas: Única

Medidas: 82x36cm

Composición:

100% Poliéster

200gr/m2

Colores:



0077
Verde
"Contraste
Beige"



5557
Beige
"Contraste
Granate"



0022
Beige



0099
Negro



Delantal Corto

Bolsillos estilo sastrería

Mod. CHAMOMIX

Código 110608

Tallas: Única

Medidas: 70x39cm

Composición:

100% Poliéster
200gr/m2

Colores:



0048 Chocolate
"Tira Beige"
0020 Beige
Claro
"Tira Chocolate"

New
New
New

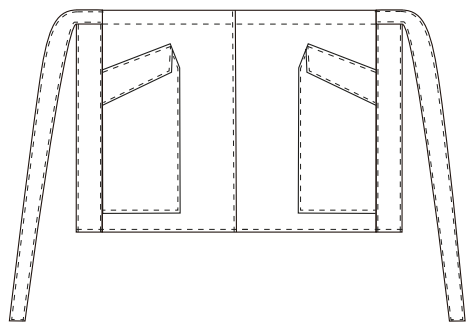



Delantal Corto

Bolsillos gran capacidad
Cinturón con hebilla
y ojeteres ajustables

Mod. CARCASONE
Código 110606
Tejido Hidroflex

Tallas:
M (57x34 cm)
L (77x36,5cm)

Composición:
100% Poliéster
132gr/m2

Colores: 
0099
Negro

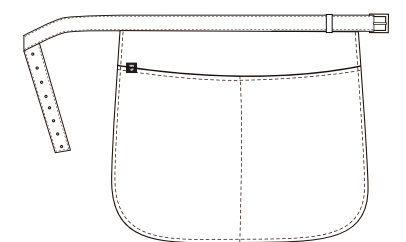

HidroFlex
Microfibra



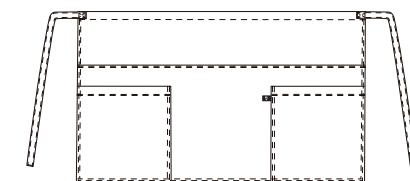

Delantal Corto

Dos bolsillos laterales de gran amplitud, Canvas



Mod. TOLÓN
Código 110610

Tallas: Única

Medidas: 78x36cm

Composición:
100% Poliéster
240gr/m2

Colores:

0022
Beige

0019
Gris Oscuro





Delantal Medio

Ecológico, Algodón Orgánico

Mod. Gaston
Código 110450

Medidas: 38x76cm

Composición:
100%Algodón Orgánico
240 gr/m²

Colores:

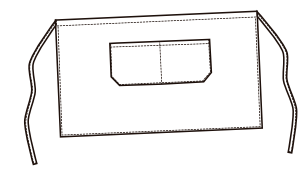

Delantal Peto

Ecológico, Algodón Orgánico

Mod. Lieja
Código 110050

Medidas: 76x88cm

Composición:
100%Algodón Orgánico
240 gr/m²

Colores:

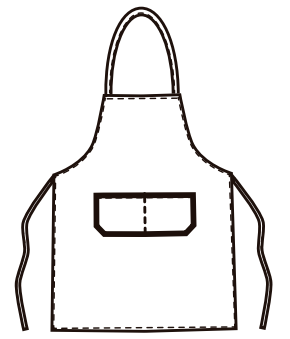
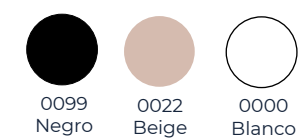



DELANTAL PETO Polipiel

Antiestrés cervical con bolsillo

Unisex

Mod. CARCASONA
Código 110028

Tallas: Única

Medidas: 72x68cm

Composición:
100% Poliéster
750gr/m2

Colores:



26812
Marrón

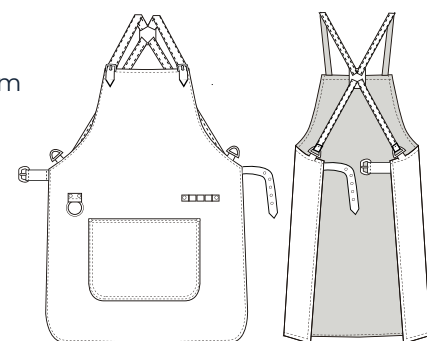

DELANTAL MEDIO Polipiel

con bolsillo

Unisex

Mod. DUNKERQUE
Código 110422

Tallas: Única

Medidas: 68x48cm

Composición:
100% Poliéster
750gr/m2

Colores:



26812
Marrón

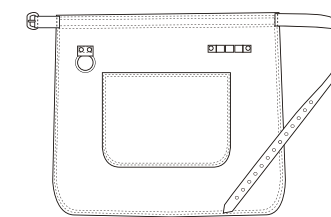



DELANTAL PETO

Contrastado
Cuadro Gales
2 bolsillos
Unisex

Mod. Anney
Código 110027

Tallas: Única

Medidas: 85x72cm

Composición tejido principal:
65% poliéster, 35% Algodón, 240gr/m2
Composición tejido contraste:
98% Algodón, 2% Spandex, 176 gr/m2

Colores:

0099
Negro

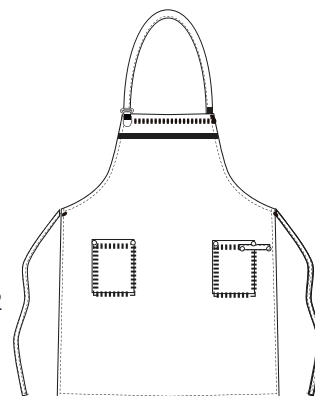
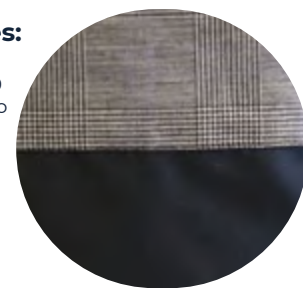

DELANTAL PETO

Rayas
Antiestrés cervical
Cruce francés
Unisex

Mod. Colmar
Código 110026

Tallas: Única

Medidas: 90x73 cm

Composición:
85% Algodón,
15% Poliéster,
290 gr/m2

Colores:

0114
Rayas
Azul

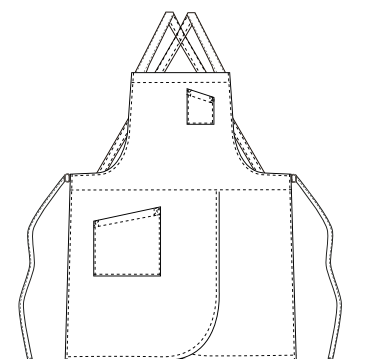

Delantal Peto

Convertible en Mandil

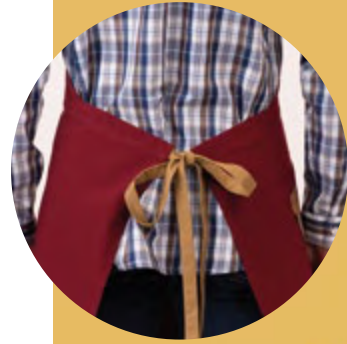

Mod. Hatten

Código: 110018

Medidas Peto: 80 x 90cm

Medidas Medio: 56 x 90 cm

Composición:

100% Acrílico Dralón®
190 gr/m²

Colores:



0099
Negro/
Gris



0023
Beige/
Chocolate



0055
Granate/
Beige

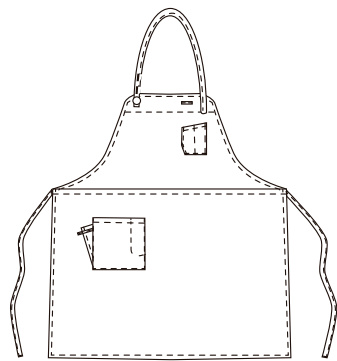

Delantal Medio

Remaches metálicos y bolsillo

Mod. Landas

Código 110420

Medidas: 38x76cm

Composición:

Sarga 100% Acrílico Dralón®
190 gr/m²

Colores:



0099
Negro



0039
Avellana

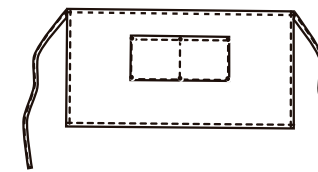

Delantal Peto

Antiestrés cervical, Bolsillo y Remaches metálicos

Mod. Aquitania

Código 110020

Medidas: 82x89cm

Composición:

Sarga 100% Acrílico Dralón®
190 gr/m²

Colores:



0099
Negro



0039
Avellana

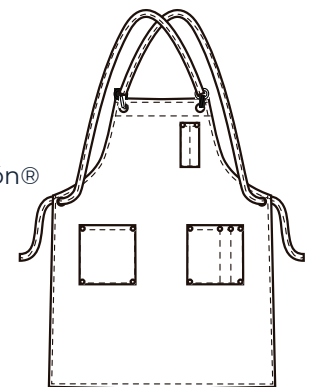



Delantal Medio Hidrofugado

Mod. Garona
Código 110421

Medidas: 36x75cm

Composición:
70% Poliéster
26% Algodón
4% Elastano
240 gr/m²

Colores:



0099 Negro

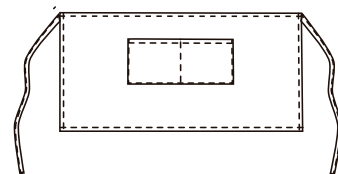

Delantal Peto Hidrofugado y Hebilla ajustable

Mod. Arras
Código 110021

Medidas: 82x89cm

Composición:
70% Poliéster
26% Algodón
4% Elastano
240 gr/m²

Colores:



0099 Negro

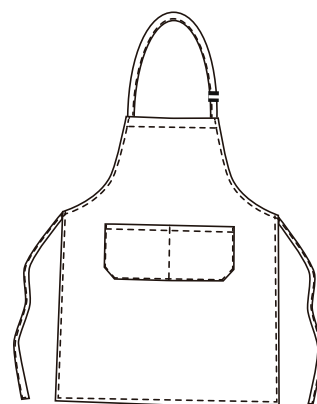

Delantal Medio Sarga Vintage

Mod. Baume
Código 110413

Medidas: 38x76cm

Composición:
-Tejido:
100% Algodón
395 gr/m²
-Arneses:
Polipiel y latón

Colores:

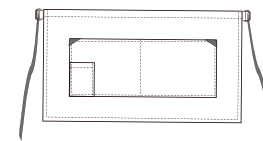
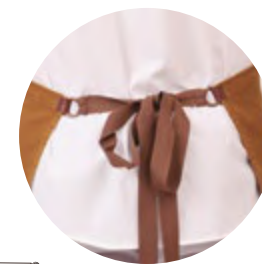
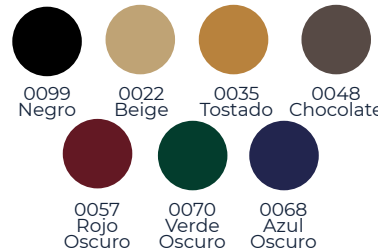

Delantal Peto Sarga Vintage

Mod. Saona
Código 110013

Medidas: 80x70cm

Composición:
-Tejido:
100% Algodón
395 gr/m²
-Arneses:
Polipiel y latón

Colores:

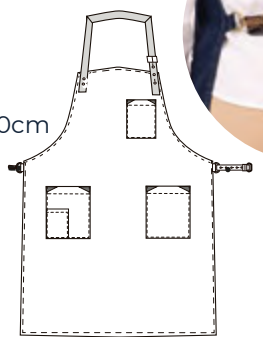
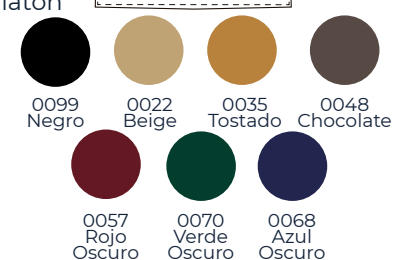



Delantal Medio

Canvas y Bolsillo para Tablet

Mod. Lot
Código 110419

Medidas: 39x73cm

Composición:
-Tejido:
100% Poliester
290 gr/m²
-Polipiel y latón

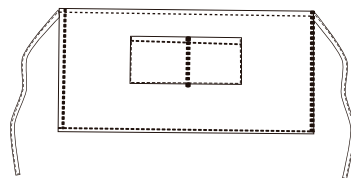

Delantal Peto

Canvas y Bolsillo para Tablet

Mod. Creuse
Código 110019

Medidas: 88x82cm

Composición:
-Tejido: 100% Poliester, 290 gr/m²
-Cintas: 100% Poliester
-Ollados
-Polipiel

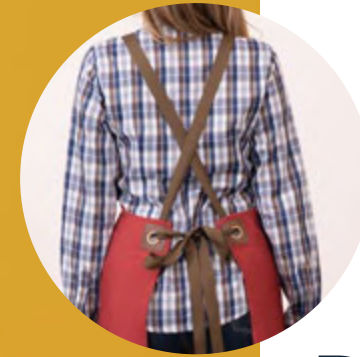
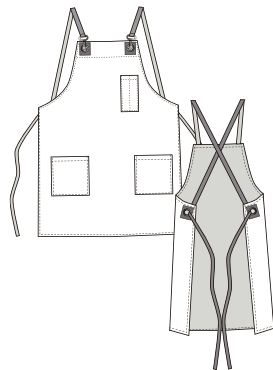

Delantal Peto

Canvas, Antiestrés cervical

Mod. Versalles
Código 110015

Medidas: 88x82cm

Composición:
-Tejido: 100% Poliester, 290 gr/m²
-Cintas: 100% Poliester
-Ollados
-Polipiel

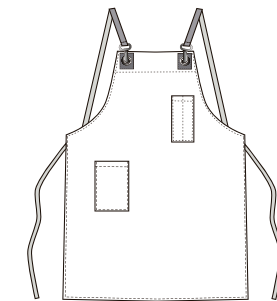



Cinta No Incluida

Delantal Peto Vaquero
con cinta intercambiable

Mod. Rennes
Código 110004

Medidas: 88x76cm

Composición:
98% Algodón
2% Elastano
6,5 Oz (185 gr/m²)

Colores:



0165 Denim
210

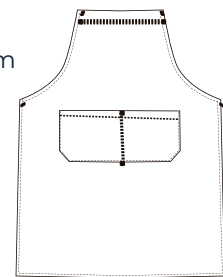

Delantal Medio Vaquero
con cinta intercambiable

Mod. Reins
Código 110403

Medidas: 48x76cm

Composición:
98% Algodón
2% Elastano
6,5 Oz (185 gr/m²)

Colores:



0165 Denim

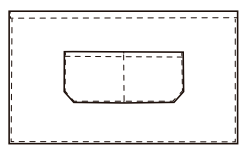

Delantal Coroto Vaquero
con cinta intercambiable

Mod. Brest
Código 110603

Medidas: 30x55cm

Composición:
98% Algodón
2% Elastano
6,5 Oz (185 gr/m²)

Colores:



0165 Denim

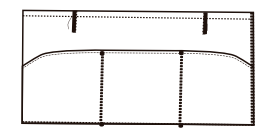

Cintas

Cinta combinable espiga
(sólo cintura)
Mod. Haarlen
Código 111604

Cinta combinable espiga
(cintura + cuello)
Mod. Marken
Código 111603

Colores:
00 Blanco, 07 Gris Perla, 19 Gris Oscuro, 99 Negro, 22 Beig, 48 Chocolate, 65 Celeste,
60 Azul Azafata, 64 Royal, 69 Marino, 21 Amarillo, 45 Amarillo Huevo, 58 Naranja,
57 Rojo, 55 Granate, 44 Rosa Chicle, 70 Verde Manzana, 72 Verde Prado, 73 Verde
Caqui, 77 Verde Botella



Cinta combinable vaquera (sólo cintura)
Mod. Haya
Código 111606

Color 165 denim



Cinta combinable vaquera (cintura + cuello)
Mod. Leiden
Código 111605

Color 165 denim

Delantal Peto

Dos Ollados y
Antiestrés Cervical



Mod. Orange

Código: 110016

Medidas: 88 x 76cm

Composición:

- Tejido: Sarga 100% Poliester, 219 gr/m²
- Tirantes: 100% Poliester
- Ollados
- Polipiel

Colores:



0099
Negro

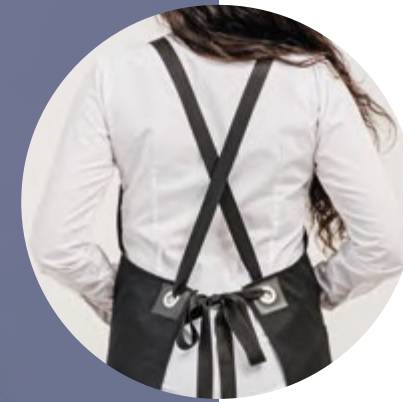
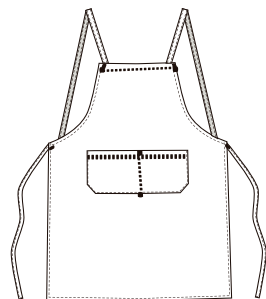

Delantal Peto

Cuatro Ollados y
Antiestrés Cervical

Mod. Sedan

Código: 110014

Medidas: 88 x 82cm

Composición:

- Tejido: Sarga 100% Poliester, 219 gr/m²
- Tirantes: 100% Poliester
- Ollados
- Polipiel

Colores:



0099
Negro

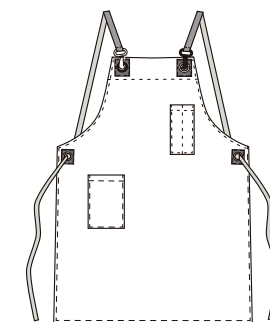



Delantal Peto Regulable

Sarga 100% Poliéster

Mod. Aix
Código 110011

Medidas: 88x76cm

Composición:
100% Poliester
219 gr/m²

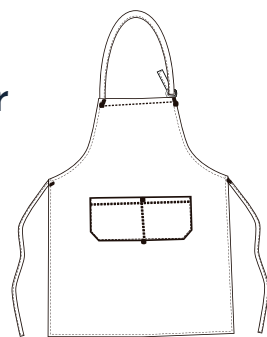

Colores:

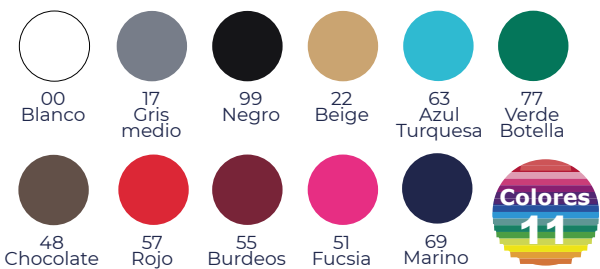

Delantal Medio

Sarga 100% Poliéster

Mod. Amiens
Código 110412

Medidas: 38x76cm

Composición:
100% Poliester
219gr/m²

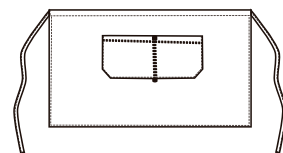

Delantal Peto

Sin bolsillos
(con ajustador)

También en Talla **XL**



Mod. Boue

Código 110009 Blanco
Código 110009C Colores

Medidas:
L - 88x76 cm
XL - 88x95 cm

Composición:
65% Poliéster
35% Algodón
195 gr/m²

Colores:

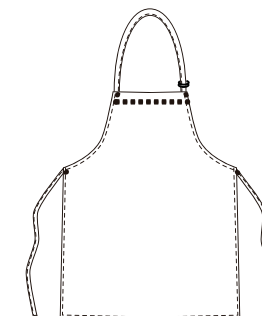



Delantal Medio Rayas

Hilo 2 cabos

Mod. Valence
Código 110411

Medidas: 38x76cm

Composición:
70% Poliéster
30% Algodón
195 gr/m²

Colores:

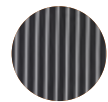

0104
Negro/Gris

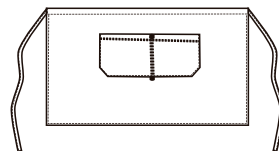

Delantal Peto Rayas

Hilo 2 cabos

Mod. Dijon
Código 110002

Medidas: 88x76cm

Composición:
70% Poliéster
30% Algodón
195 gr/m²

Colores:

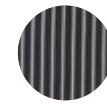

0104
Negro/Gris

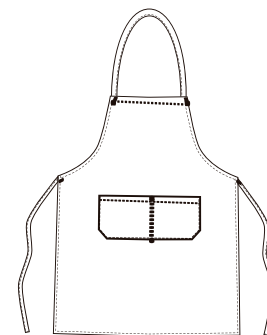

Delantal Peto

Económico
Tirantes Cruzados
Antiestrés Cervical

Mod. Pau

Código 110012 Blanco

Código 110012C Colores

Medidas: 88x76cm

Composición:

65% Poliéster
35% Algodón
195 gr/m²

Colores:



00
Blanco



17
Gris
medio



99
Negro



48
Chocolate



69
Marino



55
Burdeos



77
Verde
Botella

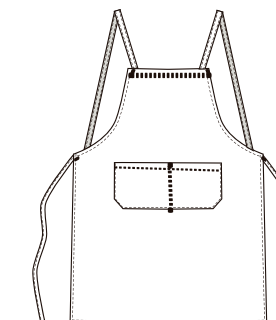

Delantal Peto

con bolsillos
(con ajustador)



También
en Talla
XL
Solo en
Blanco y Negro

Mod. Grenoble

Código 110005 Blanco
Código 110005C Colores

Medidas:

L - 88x76 cm
XL - 88x95 cm (Solo en Blanco y Negro)

Composición:

65% Poliéster
35% Algodón
195 gr/m²

Colores:

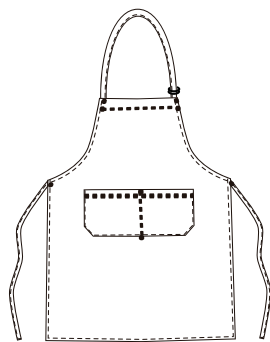
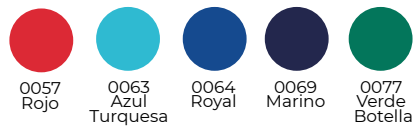

Delantal Medio

2 bolsillos

Mod. Nimes

Código 110404 Blanco
Código 110404C Colores

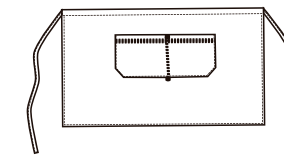

Medidas:

L - 48x76 cm
XL - 48x95 cm (Solo en Blanco y Negro)

Composición:

65% Poliéster
35% Algodón
195 gr/m²

Colores:

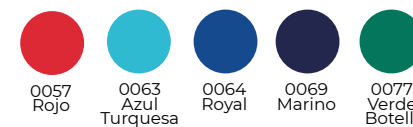

También
en Talla
XL
Solo en
Blanco y Negro

Delantal Corto

3 bolsillos

Mod. Le Mans

Código 110604 Blanco
Código 110604C Colores

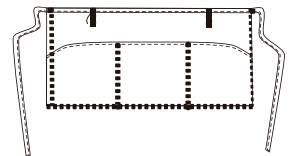

Medidas: 30x55cm

Composición:

65% Poliéster
35% Algodón
195 gr/m²

Colores:

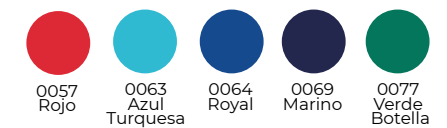

Delantal Francés

Dos bolsillos



Mod. París

Código 110201 Blanco

Código 110201C Colores

Medidas:

93x106 cm

Composición:

65% Poliéster

35% Algodón

195 gr/m²

Colores:

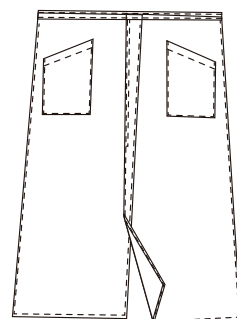
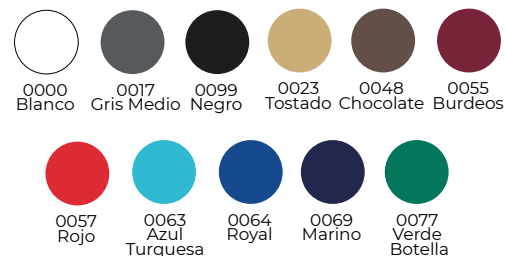

Casulla Sarga

2 Bolsillos

Mod. Loira

Código 110803 Blanco

Código 110803C Colores

Talla:

Única (84x51cm)

Composición:

65% Poliéster

35% Algodón

195 gr/m²

Colores:

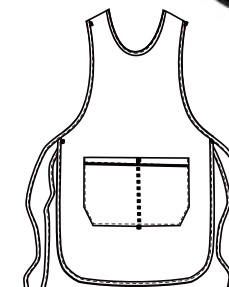

Casulla Poliéster

2 Bolsillos

Mod. Bretaña

Código 110804 Blanco

Código 110804C Colores

Talla: Única (84x51cm)

Composición:

100% Poliéster

170gr/m²

Colores:

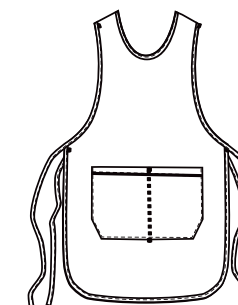



Casulla Reversible

2 bolsillos



Mod. Bayona
Código 110805

Talla:
Única (70x88cm)

Composición:
65% Poliéster
35% Algodón
195 gr/m²

Colores:

00
Blanco

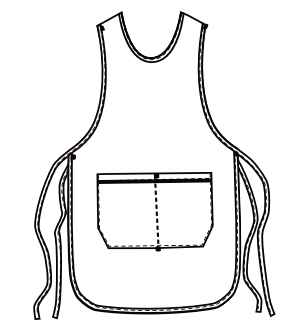



Delantal PVC colores
Plastificado

Mod. Paul
Código 110024

Medidas: 112 x 82 cm

Composición:
100% PVC Plastificado
650 gr/m²

Colores:
00 Blanco
57 Rojo

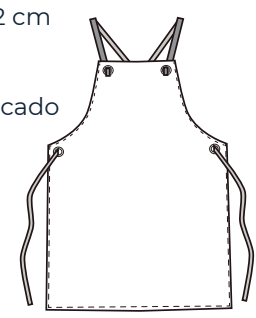

Delantal PVC/Rizo
Permite autoclave a 120°

Mod. Var
Código 110023

Medidas: 91x77 cm

Composición:
64% PVC
27% Poliéster
9% Algodón
280 gr/m²

Colores:
00 Blanco



Delantal PVC
Antiestrés cervical

Mod. Marne
Código 110022

Medidas: 109x68 cm

Composición:
91% PVC
9% Poliéster
425 gr/m²

Colores:
00 Blanco

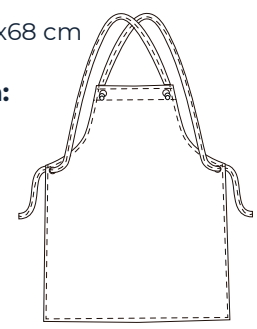

ESCAPARATE

Gorros y Cofias

Gorros

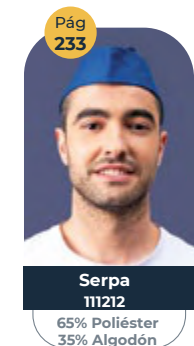
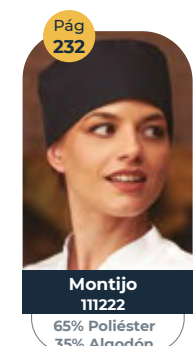
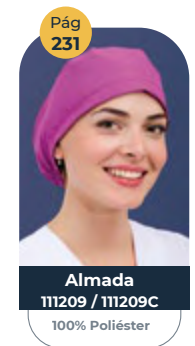
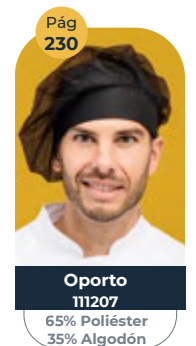
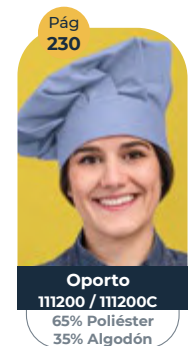

Cofias



Gorro Pirata

con Poliéster Reciclado Microfibra



Mod. Nazaret
Código 111250

Tallas:
Única

Composición:
44% Poliéster Reciclado
56% Poliéster Convencional
160gr/m²

Nido de Abeja:
100% Poliéster Convencional

Colores:

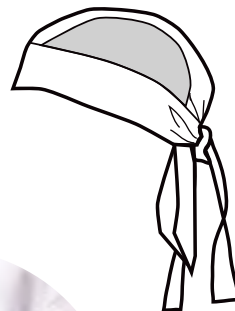

Gorro Pirata

Popelin Vigoré y Calado

Mod. Fátima
Código 111216

Talla:
Única

Composición:
65% Poliéster
35% Algodón
195 gr/m²

Nido de abeja 100% Poliéster
-125 gr/m²

Colores:



Mod. Lagos
Código 111201 Blanco
Código 111201C Colores

Talla:
Única

Composición:
65% Poliéster
35% Algodón
195 gr/m²

Colores:

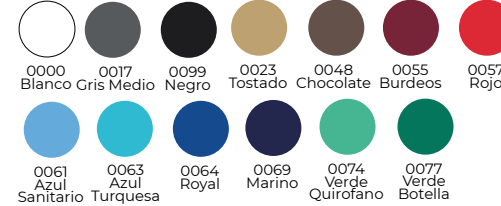

Gorro Pirata

Solitec



Mod. Tavira
Cód 111213

Talla:
Única

Composición:
100% Poliéster
160 gr/m²

Nido de abeja 100% Poliéster -125 gr/m²

Colores:

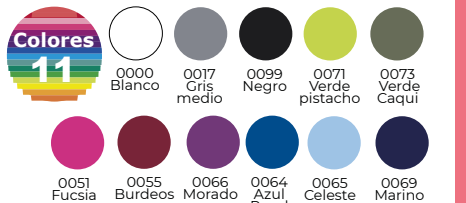

Gorro Pirata

Microfibra y Calado



Mod. Lagos
Código 111208

Talla:
Única

Composición:
65% Poliéster
35% Algodón
195 gr/m²

Rejilla 100% Poliéster
-125 gr/m²

Colores:



Gorro Pirata

Rejilla

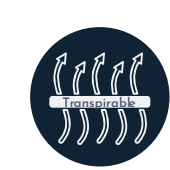



Gorro Chef con velcro

Mod. Oporto
Código 111200 Blanco
Código 111200C Colores

Talla:
Única

Composición:
65% Poliéster
35% Algodón
195 gr/m²

Colores:

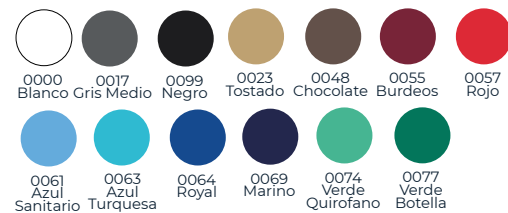

Gorro Chef Gesdry® con velcro

Mod. Oporto
Cód 111206

Talla:
Única

Composición:
65% Poliéster
35% Algodón
195 gr/m²

Gesdry
100% Poliéster
-125 gr/m²

Colores:

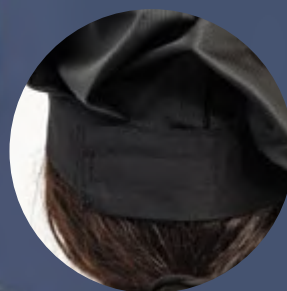
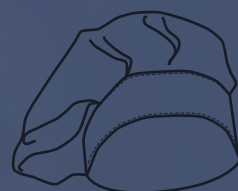

Gorro Chef Rejilla con Velcro

(Mínima abertura 54 cm, máxima 62 cm)

Mod. Oporto
Cód 111207

Talla:
Única

Composición:
65% Poliéster
35% Algodón
195 gr/m²

Rejilla 100% Poliéster
-125 gr/m²

Colores:



Gorro Quirófano

Goma Elástica
Microfibra



Mod. Almada

Código 111209 Blanco
Código 111209C Colores

Composición:
100% Poliéster
145 gr/m²

Talla:
Única

Colores:

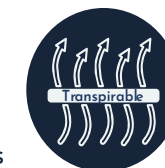

GORRO Skullcap

Cierre Ajustador
con velcro



Mod. MONTIJO

Código 111222



Talla:

Única

Composición:

65% Poliéster
35% Algodón

Gesdry

100% Poliéster
-125 gr/m²



Colores:



0099
Negro

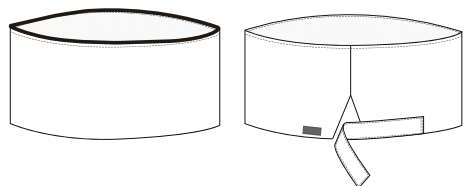

Gorro Gran Chef

Mod. Faro

Código 111202

Tallas:

54 a 62

Composición:

100% Poliéster
90 gr/m²

Colores:



0000
Blanco

0099
Negro

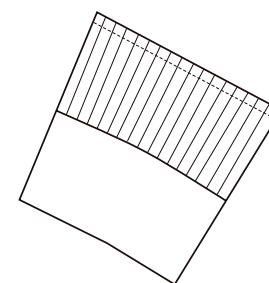

Gorro Barco Pack 5 Unidades

Mod. Serpa

Código 111212

Tallas:

56, 58, 60, 62

Composición:

65% Poliéster
35% Algodón
195 gr/m²

Rejilla 100% Poliéster
-125 gr/m²

Colores:



0000
Blanco

0099
Negro

0064
Azul
Royal

0057
Rojo

0077
Verde
Botella





Cofia Recoge Pelo

Pack 10 Unidades

Mod. Elvas
Código 111215 Blanco
Código 111215C Colores

Composición:
65% Poliéster
35% Algodón
Rejilla 100% Poliéster

Talla:
S, M, L

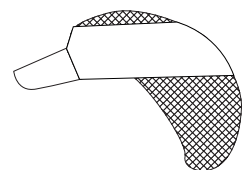
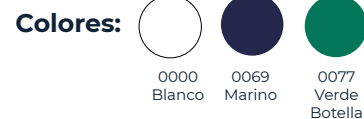

Cofia

Visera y recoge pelo de rejilla

Pack 5 Unidades

Mod. Coimbra
Cód 111219

Talla:
S, M, L

Composición:
65% Poliéster
35% Algodón
Rejilla 100% Poliéster

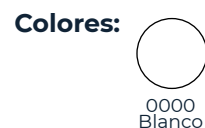

Gorra

con visera y parte superior con rejilla

Pack 10 Unidades

Mod. Óbidos
Cód 111218

Talla:
S, M, L

Composición:
65% Poliéster
35% Algodón
Rejilla 100% Poliéster



Cofia

Visera Color
Rejilla al tono

Pack 10 Unidades

Mod. Maia
Cód 111211C

Talla:
Única

Composición:
65% Poliéster
35% Algodón
195 gr/m²

Rejilla 100% Poliéster
-125 gr/m²

Colores:

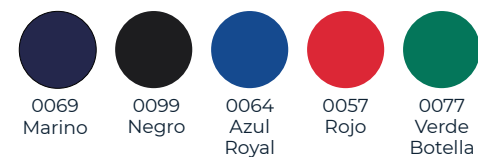

Cofia

Visera Color
Rejilla blanca

Pack 10 Unidades

Mod. Maia
Cód 111211

Talla:
Única

Composición:
65% Poliéster
35% Algodón
195 gr/m²

Rejilla 100% Poliéster
-125 gr/m²

Colores:

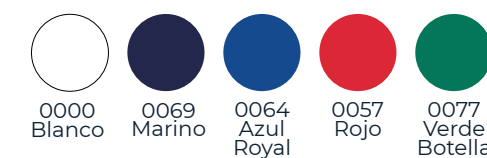

ESCAPARATE

Casacas

Casacas



- | | | | | | | |
|------------------------------------------------------------------------------------------------------------------------------------------------------------------------------------------------------------------------------|--------------------------------------------------------------------------------------------------------------------------------------------------------------------------------------------------------------------------------|-----------------------------------------------------------------------------------------------------------------------------------------------------------------------------------|------------------------------------------------------------------------------------------------------------------------------------------------------------------------------|----------------------------------------------------------------------------------------------------------------------------------------------------------------------------------|-----------------------------------------------------------------------------------------------------------------------------------------------------------------------|------------------------------------------------------------------------------------------------------------------------------------------------------------------------|
| <p>Pág 238</p>  <p>New York
114000 / 114000C
65% Poliéster
35% Algodón</p> | <p>Pág 239</p>  <p>Chicago
114002
65% Poliéster
35% Algodón</p> | <p>Pág 240</p>  <p>Charlotte
114005 / 114005C
65% Poliéster
35% Algodón</p> | <p>Pág 241</p>  <p>Belk
114009 / 114009C
65% Poliéster
35% Algodón</p> | <p>Pág 242</p>  <p>Columbus
114010 / 114010C
65% Poliéster
35% Algodón</p> | <p>Pág 243</p>  <p>Atlanta
114209
65% Poliéster
35% Algodón</p> | <p>Pág 243</p>  <p>Pasadena
114208
65% Poliéster
35% Algodón</p> |
| <p>Pág 245</p>  <p>Boston
114006 / 114006C
100% Poliéster</p> <p>Miami
114206 / 114206C
100% Poliéster</p> | <p>Pág 246</p>  <p>Newark
114007 / 114007C
100% Poliéster</p> | <p>Pág 246</p>  <p>Edmond
114011
100% Poliéster</p> | <p>Pág 247</p>  <p>Baltimore
114202
100% Poliéster</p> | <p>Pág 247</p>  <p>San Diego
114203
100% Poliéster</p> | <p>Pág 248</p>  <p>Brady
114012
100% Poliéster</p> | |
| <p>Pág 250</p>  <p>Trinidad
114014 / 114014C
100% Poliéster</p> | <p>Pág 251</p>  <p>Trenton
114106 / 114106C
100% Poliéster</p> <p>Omaha
114306 / 114306C
100% Poliéster</p> | <p>Pág 252</p>  <p>Artesia
114217
100% Poliéster</p> | <p>Pág 252</p>  <p>Roswell
114216
100% Poliéster</p> | <p>Pág 253</p>  <p>Akron
114207 / 114207C
100% Poliéster</p> | | |
| <p>Pág 255</p>  <p>San Luis
114215
100% Poliéster</p> | <p>Pág 256</p>  <p>Indiana
114210
100% Poliéster</p> | <p>Pág 257</p>  <p>Oklahoma
114016
100% Poliéster</p> | <p>Pág 258</p>  <p>Orlando
114020
100% Poliéster</p> | <p>Pág 259</p>  <p>Iowa
114400
100% Poliéster</p> | | |



Casaca Cuello pico

Unisex



Mod. New York

Código 114000 Blanco (Solitec Plus +)

Código 114000C Colores (Solitec)

Composición:

65% Poliéster, 35% Algodón
195 gr/m²

Tallas:

De la XS a la 6XL (Blanco)
De la XS a la 4XL (Colores)

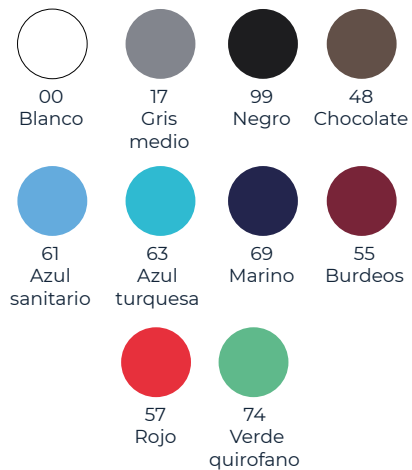

CASACA Cuello Redondo 3 bolsillos Unisex

Mod. CHICAGO

Código 114002

Composición:

65% Poliéster, 35% Algodón
195 gr/m²

Tallas:

De la 2XS a la 5XL

Colores:

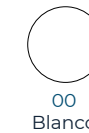

CASACA

Abierta
Cuello Pico
Botones

Unisex



Mod. CHARLOTE

Código 114005 Blanco

Código 114005C Colores

Composición:

65% Poliéster, 35% Algodón
195 gr/m²

Tallas:

De la 2XS a la 4XL

Colores:

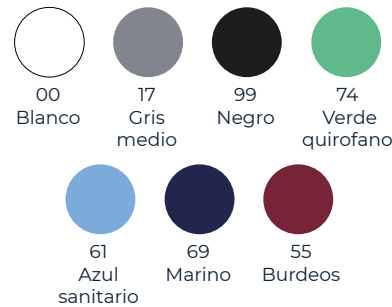

CASACA

Cuello pico
Broches

Unisex



Mod. BELK

Código 114009 Blanco

Código 114009C Negro

Composición:

65% Poliéster, 35% Algodón
195 gr/m²

Tallas:

De la XS a la 3XL

Colores:



CASACA

Sarga

Manga Larga

3 bolsillos

Unisex



Mod. COLUMBUS

Código 114010

Código 114010C Negro

Composición:

65% poliéster, 35% algodón
195 gr/m²,

Tallas:

De la XS a la 5XL

Colores:

00 Blanco 99 Negro

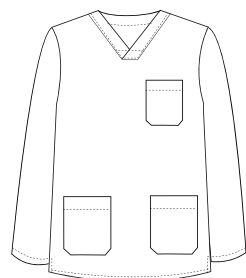

Casaca

Manga Larga

Cuello Chimenea

Cremallera

Mod. ATLANTA

Código 114209

Composición:

65% Poliéster
35% Algodón
195 gr/m²

Tallas:

De la XS a la 2XL

Colores:

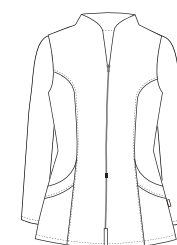

Casaca

Manga corta

Cuello Chimenea

Cremallera

Mod. PASADENA

Código 114208

Composición:

65% Poliéster
35% Algodón
195 gr/m²

Tallas:

De la XS a la 2XL

Colores:

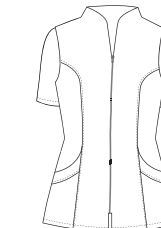

Comodidad en cada fibra

LAVADO Y SECADO FÁCIL
 La tecnología aplicada a la hilatura hace que no sufra durante el lavado y el agua no penetre en el tejido, con lo que el tiempo de secado es mínimo.

HIDROFUGADO
 La composición química que se aplica a través de la nanotecnología, confiere a nuestro tejido propiedades hidrófugas.

ALTA DURABILIDAD DEL COLOR
 La tecnología Nanotec, junto con los tintes de máximo rendimiento, hacen que los colores sigan permaneciendo a lo largo del tiempo.



LIGERO
 Nuestro hilatura, al ser hueca, hace que sea una prenda extremadamente ligera frente a otras microfibras.

TRANSPIRABLE
 Testada en laboratorio, y con notas muy altas en la resistencia al vapor de agua, hacen que nuestra microfibra sea única entre las microfibras del sector.

NanoTec
 Technology

Con esta tecnología revolucionaria hemos creado una composición química a nivel molecular que se le aplica al tejido y que le da unas propiedades hidrófugas. Con ello conseguimos que las prendas tengan una durabilidad mas alta sin perder sus prestaciones.



CASACA Microfibra

Tejido Calado en hombros y costados

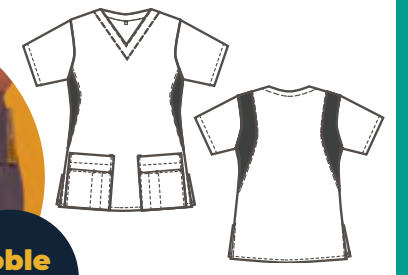

Doble Bolsillo

Caballero

Mod. BOSTON
 Código 114006 Blanco
 Código 114006C Colores

Composición:
 100% Poliéster
 145 gr/m²

Tallas:
 De la XS a la 4XL



Señora

Mod. MIAMI
 Código 114206 Blanco
 Código 114206C Colores

Composición:
 100% Poliéster
 145 gr/m²

Tallas:
 De la XS a la 2XL

Colores
11

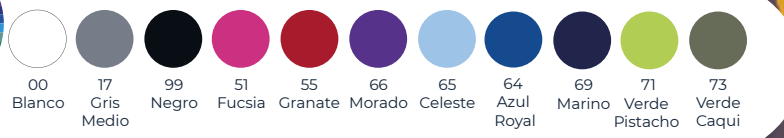



NanoTec

Casaca Cuello pico Económica

Mod. NEWARK
Código 114007 Blanco
Código 114007C Colores

Composición:
100% Poliéster
145 gr/m²

Tallas:
De la XS a la 4XL

Colores:

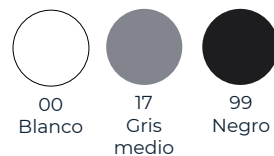

Unisex

Casaca Microfibra Manga larga 3 bolsillos

Mod. EDMOND
Código 114011

Composición:
100% Poliéster
145 gr/m²

Tallas:
De la XS a la 4XL

Colores:
00 Blanco

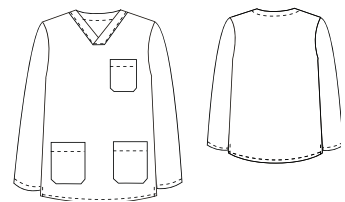

Unisex

Casaca Con Mangas Cuello pico Cremallera

Mod. BALTIMORE
Código 114202

Composición:
100% Poliéster
165 gr/m²

Tallas:
De la XS a la 2XL

Colores:

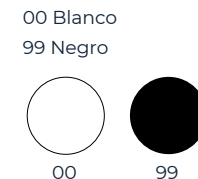

Casaca Sin Mangas Cuello pico Cremallera

Mod. SAN DIEGO
Código 114203

Composición:
100% Poliéster
165 gr/m²

Tallas:
De la XS a la 2XL

Colores:

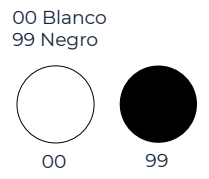

Casaca Microfibra

Cuello cruzado
Vivos en cuello
y bolsillos

Unisex



Mod. BRADY
Código 114012

Composición:
100% Poliéster
145 gr/m²



Tallas:
De la XS a la 3XL

Color de vivos:



65
Celeste

51
Fucsia

74
Verde
Quirófano

"Color base de
la casaca en blanco"

NanoTec



Casaca Microfibra

Cuello pico

Broches

Unisex

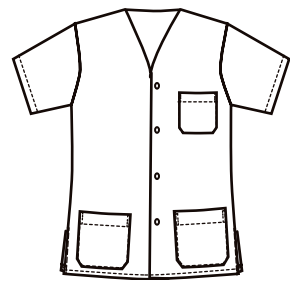

Mod. TRINIDAD

Código 114014 Blanco
Código 114014C Negro

Composición:

100% Poliéster
145 gr/m²

Tallas:

De la XS a la 3XL

Colores:

00 Blanco 99 Negro



Casaca Microfibra

Manga larga

Cuello Mao

Broches ocultos

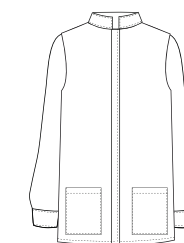

Caballero

Mod. TRENTON

Código 114106
Código 114106C Negro

Composición:
100% Poliéster
145 gr/m²

Tallas:
De la XS a la 3XL

Colores:

00 Blanco 99 Negro



Señora

Mod. OMAHA

Código 114306
Código 114306C Negro

Composición:
100% Poliéster
145 gr/m²

Tallas:
De la XS a la 2XL

Colores:

00 Blanco 99 Negro

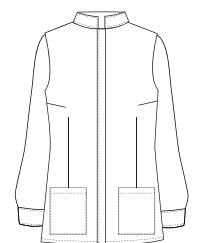



Casaca

Manga Larga
Microfibra
Cuello Chimenea
Cremallera

Mod. ARTESIA
Código 114217

Composición:
100% Poliéster

Tallas:
De la XS a la 2XL
145 gr/m²

Colores:

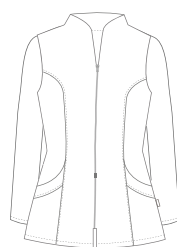

Casaca

Manga corta
Microfibra
Cuello Chimenea
Cremallera

Mod. ROSWELL
Código 114216

Composición:
100% Poliéster

Tallas:
De la XS a la 2XL
145 gr/m²

Colores:

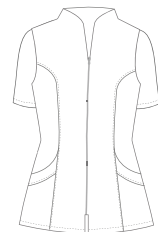
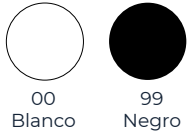

Casaca

Microfibra
Broche Rectangular
Señora

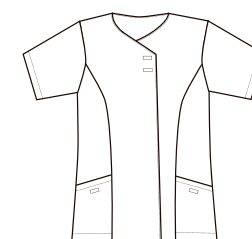

Mod. AKRON
Código 114207 Blanco
Código 114207C Colores

Composición:
100% Poliéster
145 gr/m²

Tallas:
De la XS a la 2XL

Colores:

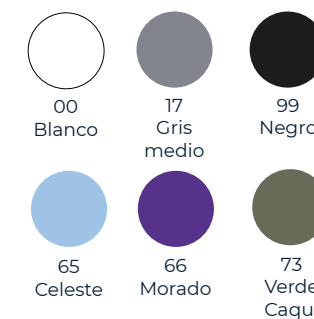

Respira con **Hidroflex**.
La microfibra **elástica** que **transpira**.



ELÁSTICO
Nuestro innovador hilo elástico hace que prescindamos de elásticos, menos resistentes, y que pierden sus características con las temperaturas altas y los productos agresivos.



LAVADO Y SECADO FÁCIL
La tecnología aplicada a la hilatura hace que no sufra durante el lavado y el agua no penetre en el tejido, con lo que el tiempo de secado es mínimo.



HIDROFUGADO
La composición química que se aplica a través de la nanotecnología, confiere a nuestro tejido propiedades hidrófugas.



ALTA DURABILIDAD DEL COLOR
La tecnología Nanotec, junto con los tintes de máximo rendimiento, hacen que los colores sigan permaneciendo a lo largo del tiempo.



LIGERO
Nuestra hilatura, al ser hueca, hace que sea una prenda extremadamente ligera frente a otras microfibras.



TRANSPIRABLE
Testada en laboratorio, y con notas muy altas en la resistencia al vapor de agua, hacen que nuestra microfibra sea única entre las microfibras del sector.



NanoTec
Technology

Con esta **tecnología revolucionaria** hemos creado una composición química a nivel molecular que se le aplica al tejido y que le da unas **propiedades hidrófugas**. Con ello conseguimos que las prendas tengan una **durabilidad** mas alta sin perder sus prestaciones.

Casaca Microfibra

Tejido **Elástico**
Doble bolsillo
Cruzada

Señora

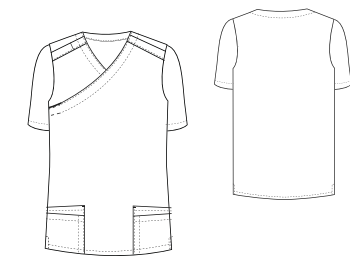

Mod. SAN LUIS
Código 114215



Composición:
100% Poliéster
132 gr/m²



Tallas:
De la XS a la 2XL

- Colores:**
- 2072 Agua
 - 2065 Celeste
 - 2068 Petróleo
 - 2000 Blanco
 - 2099 Negro



Casaca Microfibra

Doble bolsillo

Tejido **Elástico**

Señora

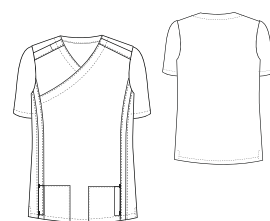

Mod. INDIANA
Código 114210

Composición:
100% Poliéster
132 gr/m²

Tallas:
De la XS a la 2XL

Colores:



Casaca Microfibra

Tejido **Elástico**

Canesú

3 bolsillos

Unisex

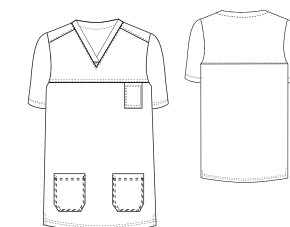

Mod. OKLAHOMA
Código 114016

Composición:
100% Poliéster
132 gr/m²

Tallas:
De la XS a la 4XL

Colores:

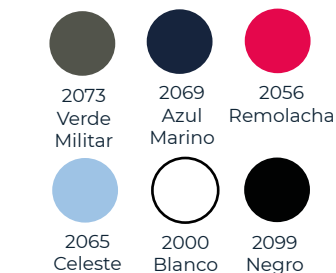

NanoTec 257

CASACA

Microfibra

Tejido Elástico

Unisex



Mod. Orlando
Código 114020

Composición:
100% Poliéster
132 gr/m²

Tallas:
De la XS a la 4XL

Colores:

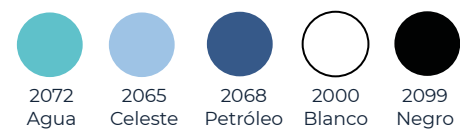

Polo

Microfibra

Elástico y Tejido Calado

Unisex

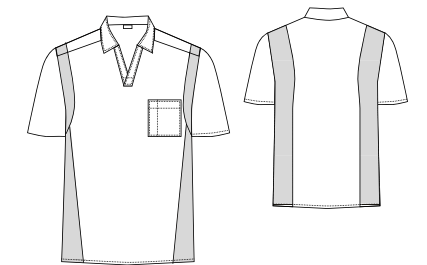

Mod. IOWA
Código 114400

Composición:
100% Poliéster
132 gr/m²

Tallas:
De la S a la 4XL

Colores:





ESCAPARATE

Batas Y Pijamas

Batas



Pijamas



Bata

Tres bolsillos

Unisex



Mod. OXFORD

Código 113600 (Solitec Plus+)

Código 113600C (Solitec)

Composición:

65% Poliéster

35% Algodón

195 gr/m²

Tallas:

De la 2XS a la 4XL

Colores:



00
Blanco



69
Marino

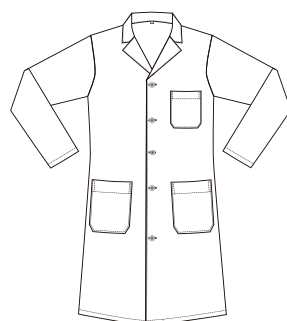

Bata

Entallada

Tres bolsillos

señora



Mod. LONDRES

Código 113601 Blanco

Composición:

65% Poliéster

35% Algodón

195 gr/m²

Tallas:

De la 2XS a la 2XL

Colores:

00 Blanco

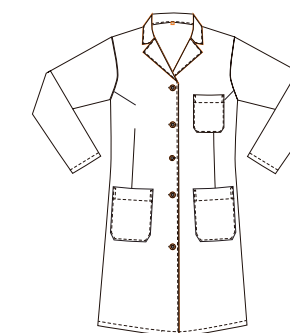

Bata Cruzada con Botones Tejido **Elástico** Entallada Señora



Mod. PRESTON

Código 113611

Composición:

55% Algodón
42% Poliéster
3% Elastano
173 gr/m²

Tallas:

De la XS a la 2XL

Colores:

00 Blanco



Bata

Cuello Fantasía con botones Tejido **Elástico** Señora



Mod. DERBY

Código 113610

Composición:

55% Algodón
42% Poliéster
3% Elastano
173 gr/m²

Tallas:

De la XS a la 2XL

Colores:

00 Blanco



Bata Microfibra con Botones Corta y con doble bolsillo Tejido **Elástico** Señora

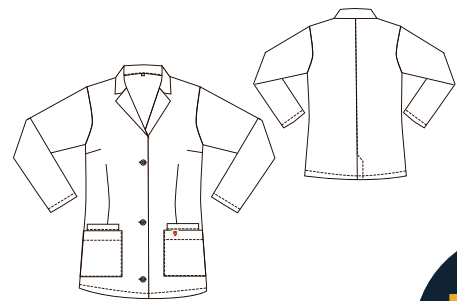

**Doble
Bolsillo**

Mod. WALES
Código 113613

Composición:
100% Poliéster
145 gr/m²

Tallas:
De la XS a la 2XL

Colores:

00 Blanco



Bata Microfibra Broches Unisex



Mod. TULSA
Código 113603

Composición:
100% Poliéster
145 gr/m²

Tallas:
De la 2XS a la 3XL

Colores:
00 Blanco



Bata

Microfibra

con Botones

Entallada

Tejido Elástico

Señora

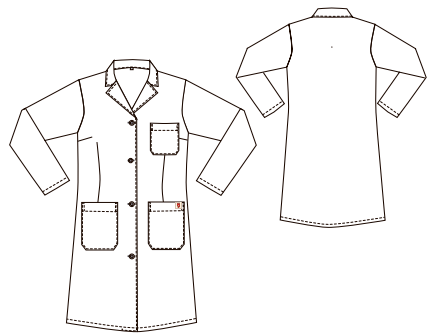



Mod. NORWICH
Código 113612

Composición:
100% Poliéster
132 gr/m²

Tallas:
De la XS a la 2XL

Colores:

-  2000 Blanco
-  2072 Agua
-  2068 Petróleo



Conjunto Sanitario

Unisex



Mod. BIBB
Código 115001

Composición:
65% Poliéster, 35% Algodón
195 gr/m²

Tallas:
115001: De la XS a la 4XL

Colores:
00 Blanco

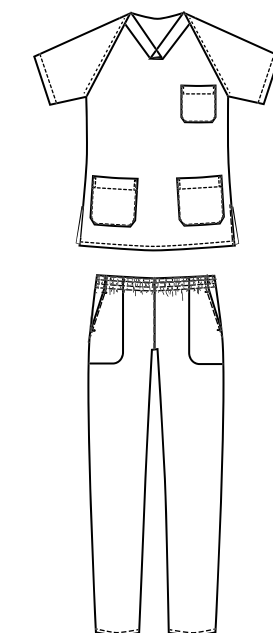

ESCAPARATE

Industria Alimentaria

Casacas



Pantalones



Batas



Balaclavas



Manguitos





CASACA

Microfibra
Sin bolsillos externos

Mod. RENO
Código 114019

Composición:
100% Poliéster
145 gr/m²

Tallas:
De la XS a la 3XL

Colores:

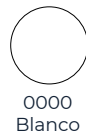

0000
Blanco



Unisex



NanoTec



CASACA

Sin bolsillos
externos

Mod. LOS ÁNGELES
Código 114017

Composición:
65% Poliéster
35% Algodón
195 gr/m²

Tallas:
De la XS a la 3XL

Colores:



0000
Blanco



Unisex



CASACA

Sin bolsillos
Puño elástico

Unisex



Mod. Las Vegas
Código 114018

Tallas:
De la XS a la 3XL

Composición:
65% Poliéster
35% Algodón
195 gr/m²

Colores:
0000 Blanco





Pantalón con un bolsillo interior con velcro

PANTALÓN

Goma Entera

Sin bolsillos externos
Un bolsillo interior con velcro

Unisex



Mod. Bruselas
Código 112213

Tallas:
De la XS a la 3XL

Composición:
65% Poliéster
35% Algodón
195 gr/m²

Colores:
0000 Blanco

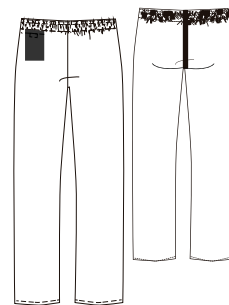

PANTALÓN

Microfibra

Sin Bolsillos externos

Unisex



Pantalón con un bolsillo interior con velcro

Mod. Lovaina
Código 112214

Tallas:
De la XS a la 3XL

Composición:
100% Poliéster
145 gr/m²

Colores:
0000 Blanco

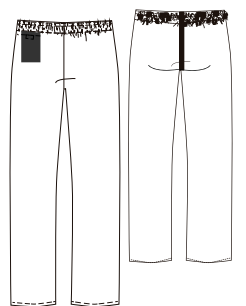

BATA

con tapeta,
broches ocultos,
puño en manga y
bolsillo interior

Unisex



Mod. Manchester

Código 113614

Tallas:

De la XS a la 3XL

Composición:

65% Poliéster
35% Algodón
195 gr/m²

Colores:

0000 Blanco

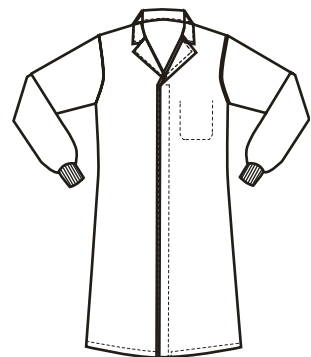

BATA

Bata con tapeta,
velcro, puño en
manga y bolsillo
interior

Unisex



Mod. York

Código 113615

Tallas:

De la XS a la 3XL

Composición:

65% Poliéster
35% Algodón
195 gr/m²

Colores:

0000 Blanco



Balacclavas Sarga

Mod. Guarda
Cód 111220

Talla:
Única

Composición:
65% Poliéster
35% Algodón
195 gr/m²

Colores:

0000 Blanco

Manguitos Sarga

Mod. Berlín
Cód 120001

Talla:
Única

Composición:
65% Poliéster
35% Algodón
195 gr/m²

Colores:

0000 Blanco

Balacclavas Rejilla

Pack 10 Unidades

Mod. Sintra
Cód 111221

Talla:
Única

Composición:
Rejilla 100% Poliéster

Colores:

0000 Blanco

Manguitos PVC

Mod. Munich
Cód 120000

Talla:
Única

Composición:
75% PVC
25% Poliéster
(Malla interna)

Colores:

0000 Blanco

Alta Visibilidad



Testado con aitex Clase 1 y Clase 2

Ha obtenido la Certificación de Examen UE de Tipo del EPI correspondiente al presente certificado, conforme a lo expresado en el Reglamento (UE) 2016/425 y de acuerdo con los procedimientos de ensayo y especificaciones técnicas aplicables.

Destinado a la señalización de la presencia diurna y nocturna del usuario en situaciones de peligro de baja visibilidad, según la/s Norma/s:

- EN ISO 13688:2013 requisitos generales. (Aplicado en el modelo 5001)
- EN ISO 13688:2013 / A1:2021 requisitos generales. (Aplicado en el modelo 5002).
- EN ISO 20471:2013/A1:2016 como prenda de Clase 1 y Clase 2 para alto riesgo de baja visibilidad. (Aplicado en el modelo 5001 y 5002)

EN ISO 20471



EN ISO 20471



Chaleco Alta Visibilidad bandas reflectantes Unisex

Mod. Halley
Código 5001

Composición:
100% Poliéster
120gr/m²

Tallas:
(De la S a la 3XL)
- Clase 1: de la S a la M
- Clase 2: de la L a la 3XL

Colores disponibles:



Chaleco Alta Visibilidad Cierre central de cremallera Unisex

Mod. Kuiper
Código 5002

Composición:
100% Poliéster
120gr/m²

Tallas:
(De la S a la 3XL)
- Clase 2: de la S a la 3XL

Colores disponibles:

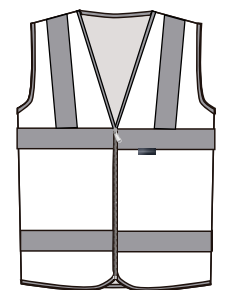



Tejido con Tecnología NanuTec y Certificado Confort Plus 3

Desde hace años hemos utilizado esta hilatura propia para conseguir una segunda piel con nuestros productos térmicos, haciendo que seamos número uno en el sector. Pioneros en testar estas prendas en laboratorio con notas sensacionales.

Hay muchas prendas térmicas, pero sólo un NANU-TEC.

El tejido con **tecnología Nanutech, un tejido inteligente** que destaca por tener una gran adaptabilidad a la temperatura externa, ya que cuando hace frío se cierra para que este no pase y así mantener el calor. Además del aislamiento térmico tiene una gran transpirabilidad y confortabilidad.



ESCAPARATE

Ropa Térmica

<p>Nanuq 6001 82% Poliéster 13% Poliamida 5% Elastano</p>	<p>Amiat 6007 82% Poliéster 13% Poliamida 5% Elastano</p>	<p>Aarluk 6004 / 6004C 82% Poliéster 13% Poliamida 5% Elastano</p>	<p>Siku 6005C 65% Poliéster 35% Poliamida</p>	<p>Sila 6008 50% Poliéster 50% Algodón</p>	<p>Nanuraq 6101 82% Poliéster 13% Poliamida 5% Elastano</p>	<p>Silami 6108 50% Poliéster 50% Algodón</p>
------------------------------------------------------------------------------	------------------------------------------------------------------------------	---------------------------------------------------------------------------------------	--------------------------------------------------------------	-----------------------------------------------------------	--------------------------------------------------------------------------------	-------------------------------------------------------------

CAMISETA TÉRMICA

de cuello caja
Unisex

Mod. Nanuq
Código 6001

Características:

La camiseta térmica Nanuq está diseñada para el uso continuo en condiciones adversas de **frío y humedad**, proporcionando al trabajador:

- Aislamiento térmico.
- Transpirabilidad.
- Ligereza.
- Adaptabilidad.
- Confortabilidad.



Composición:

82% Poliéster
13% Poliamida
5% Elastano
173 gr/m²

Tallas:

De 2XS/XS a 2XL/3XL

Colores:

Negro 99, Blanco 00



*Pruebas realizadas por AITEX



Sin costuras

Máxima Adaptabilidad

Zona Ventilación

Zona Torsión

Mayor Sujeción

Zona Ventilación



CAMISETA Y PANTALÓN

Térmico Unisex

La camiseta y el pantalón térmico están diseñados para el uso continuo en condiciones adversas de **frío y humedad**, proporcionando al trabajador:

- Aislamiento térmico.
- Transpirabilidad.
- Ligereza.
- Adaptabilidad.
- Confortabilidad.



*Pruebas realizadas por AITEX

Composición:
82% Poliéster
13% Poliamida
5% Elastano
173 gr/m²

Tallas:
De 2XS/XS a 2XL/3XL

Colores Camiseta:

Negro 99

Colores Pantalón:

Negro 99, blanco 00

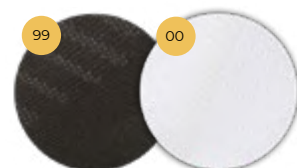

Camiseta:
Mod. Amiat
Código 6007

Pantalón:
Mod. Nanuraq
Código 6101 Negro



Sin costuras

Cuello Semicisne



CAMISETA TÉRMICA de cuello Semicisne

Unisex

Características:

La camiseta térmica Aarluk de cuello **semicisne** está diseñada para el uso continuo en condiciones adversas de **frío y humedad**, proporcionando al trabajador:

- Aislamiento térmico.
- Transpirabilidad.
- Ligereza.
- Adaptabilidad.
- Confortabilidad.



*Pruebas realizadas por AITEX

Composición:
82% Poliéster
13% Poliamida
5% Elastano
173 gr/m²

Tallas:
De 2XS/XS a 2XL/3XL

Colores: Negro 99, Azul catiónico 69

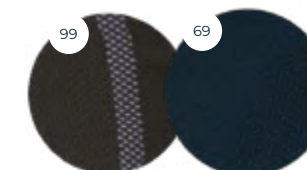

Mod. Aarluk
Código 6004 Negro
Código 6004C Azul



CAMISETA

Térmica Doble Uso

Unisex

Mod. Siku
Código 6005C
Marino



Características:

Gracias a la **tecnología en el diseño** y en la fabricación y al uso de una **hilatura muy fina** conseguimos un **tejido microperforado, cómodo** y con un ajuste perfecto al cuerpo, sin el uso de elastano u otra fibra elástica.

El **hilo multifilamento** proporciona una **termorregulación corporal inteligente**, adaptando la temperatura interior a la exterior, consiguiendo además, una rápida evacuación en la transpiración y una **alta reducción del olor corporal**.

Simplificamos las costuras para **evitar problemas con la piel**.

La microperforación consigue una **ligereza máxima** de la prenda unos **70 gramos**, dependiendo de la talla.

Composición:

65% Poliéster
35% Poliamida microfibra
112 gr/m²

Tallas:

De 2XS/XS a 2XL/3XL

Colores: Azul catiónico 69



CAMISETA Y PANTALÓN

Térmico
Unisex

Camiseta

Mod. Sila
Código 6008

Pantalón

Mod. Silami
Código 6108

Características:

Confeccionados en un **tejido interlock de 250 gr/m²**.

La camiseta es de **manga larga y cuello redondo**.

Es un artículo para los que buscan un **precio económico** y no necesitan cualidades técnicas.

Composición:

50% Poliéster
50% Algodón
250 gr/m²

Tallas:

De 2XS a 3XL

Colores: Blanco 00, Gris 17, Azul Marino 69



Calcetines

ESCAPARATE Calcetines

Calcetines para Industria

<p>Pág 290</p> <p>Buckle 1034 75% Poliéster 23% Poliamida 2% Elastano</p>	<p>Pág 291</p> <p>Uka 1036 45% Polipropileno 27% Poliamida 20% Poliéster 8% Elastano</p>	<p>Pág 292</p> <p>Vulcano 1005 70% Thermolite 26% Poliamida 3% Elastodieno 1% Elastomero</p>	<p>Pág 292</p> <p>Loa 1015 70% Thermolite 26% Poliamida 3% Elastodieno 1% Elastomero</p>	<p>Pág 293</p> <p>Fujiyama 1006 62% Coolmax 33% Poliamida 4% Elastodieno 1% Elastomero</p>	<p>Pág 294</p> <p>Etna 1020 58% Acrílico, 25% Lana 14% Poliamida 2% Elastómero 1% Elastodieno</p>	<p>Pág 294</p> <p>Vesubio 1021 58% Acrílico, 25% Lana 14% Poliamida 2% Elastómero 1% Elastodieno</p>
<p>Pág 295</p> <p>Lanín 1026 75% Algodón 23% Poliéster 2% Elastano</p>	<p>Pág 296</p> <p>Colima 1024 80% Algodón 18% Poliamida 2% Elastodieno</p>	<p>Pág 296</p> <p>Tacora 1025 80% Algodón 18% Poliamida 2% Elastodieno</p>	<p>Pág 297</p> <p>Antuco 1027 68% Lana 29% Poliamida 3% Elastómero</p>	<p>Pág 298</p> <p>Kau 1032 82% Poliéster 13% Poliamida 5% Elastano</p>	<p>Pág 299</p> <p>Dana 1035 20% Coolmax, 28% Polipropileno, 29% Poliamida 15% Poliéster 8% Elastano</p>	<p>Pág 300</p> <p>Saba 1037 47% Algodón, 19% Lana 19% Polipropileno, 18% Poliamida, 2% Elastano</p>

Calcetines para Servicio

<p>Pág 301</p> <p>Pichincha 1002 80% Algodón 18% Poliamida 2% Elastodieno</p>	<p>Pág 302</p> <p>Krakatoa 1009 73% Thermolite 21% Poliamida 2% Elastomero 4% Elastodieno</p>	<p>Pág 303</p> <p>Teide 1008 73% Algodón 21% Poliamida 2% Elastodieno 4% Elastodieno</p>	<p>Pág 304</p> <p>Stromboli 1010 73% Algodón 21% Poliamida 2% Elastomero 4% Elastodieno</p>	<p>Pág 305</p> <p>Aracar 1033 100% Algodón</p>
--------------------------------------------------------------------------------------------------	----------------------------------------------------------------------------------------------------------------------	-----------------------------------------------------------------------------------------------------------------	--------------------------------------------------------------------------------------------------------------------	-----------------------------------------------------------

Calcetines Terapéuticos y deportivos

<p>Pág 307</p> <p>Compressor 1029 62% Poliéster 34% Poliamida 4% Elastómero</p>	<p>Pág 308</p> <p>Orizaba 1022 80% Algodón 18% Poliamida 2% Elastodieno</p>	<p>Pág 309</p> <p>Santorín 1011 80% Algodón 16% Poliamida 2% Elastodieno 1% Elastómero</p>
----------------------------------------------------------------------------------------------------	------------------------------------------------------------------------------------------------	-------------------------------------------------------------------------------------------------------------------

Tejido con Tecnología **NanuTec** y Certificado **Confort Plus 3**



Desde hace años hemos utilizado esta hilatura propia para conseguir una segunda piel con nuestros productos térmicos, haciendo que seamos número uno en el sector. Pioneros en testar estas prendas en laboratorio con notas sensacionales.

Hay muchos calcetines térmicos, pero sólo un NANUTEK.

El tejido con **tecnología Nanutec**, un **tejido inteligente** que destaca por tener una gran adaptabilidad a la temperatura externa, ya que cuando hace frío se cierra para que este no pase y así mantener el calor. Además del aislamiento térmico tiene una gran transpirabilidad y confortabilidad.





CALCETÍN con hilatura Soft Air con refuerzos

Mod. Buckle
Código 1034

*Pruebas realizadas por AITEX

Características:

El calcetín técnico **Buckle** está fabricado con la misma hilatura de Soft Air plus que nuestra camiseta térmica Nanuq.

- Tecnología NanuteC, incluye refuerzos de poliamida.
- Alta capacidad de transpiración,
- Buena capacidad de regulación térmica.
- Anti pilling.
- Alto poder antibacteriano, no genera olores.

Composición:

75% Poliéster
23% Poliamida
2% Elastano

Tallas:
M (36 a 39)
L (40 a 44)
XL (45 a 48)

Colores:
Negro 99

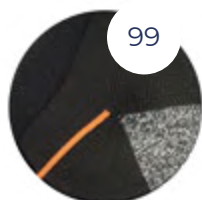

CALCETÍN Semi-compresivo

Mod. Uka
Código 1036

.....

Características:

El calcetín **semi-compresivo Uka** fabricado con una proporción media de **polipropileno absorbe y elimina la humedad** y proporciona una sensación suave contra la piel. Con **canales de ventilación** y con un diseño especial que da **máxima adaptación al tobillo** y permite un buen movimiento en esta zona.

El diseño del calcetín no es simétrico y por tanto es **único para el pie izquierdo y para el derecho**.

Sin costuras y transpirable, hacen de él un producto ideado para **el calzado de protección** y para **uso general**.

Composición:
45% Polipropileno
27% Poliamida
20% Poliéster
8% Elastano

Tallas:
M (36 a 39)
L (40 a 44)
XL (45 a 48)

Colores:
Negro 99

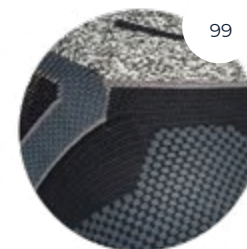



Mod. Vulcano
Código 1005

Mod. Loa
Código 1015

CALCETÍN técnico de Thermolite®

Características:
El calcetín técnico Vulcano está fabricado con fibras de última generación Thermolite®.
-Con poliamida antibacteriana para evitar olores.



Apto para distintos usos, y especialmente indicado en actividades que se desarrollen en el exterior y, en general, para aquellos entornos laborales con temperaturas bajas.

Recomendable para llevar con botas de piel hidrofugadas y/o con membranas transpirables e impermeables.

Colores: Gris 05, Negro 99, Azul 69

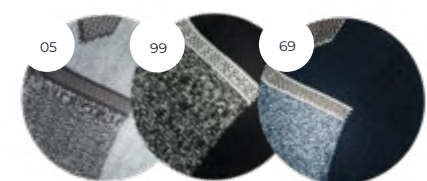

Composición:
70% Thermolite®
26% Poliamida
3% Elastodieno
1% Elastómero

Tallas:
M (36 a 39)
L (40 a 44)
XL (45 a 48)

El calcetín Loa es la versión larga, hasta la rodilla, del Vulcano



Solo en el color 99

CALCETÍN técnico de Coolmax®

Mod. Fujiyama
Código 1006



Características:
El calcetín técnico Fujiyama está fabricado en fibras de última generación Coolmax®.
-Con poliamida antibacteriana para evitar olores.

Apto para distintos usos, y especialmente indicado en actividades que se desarrollen en el exterior y, en general, para aquellos entornos laborales con temperaturas medias y donde se necesita una alta transpirabilidad.

Recomendable para llevar con botas de piel hidrofugadas y/o con membranas transpirables e impermeables.

Composición:
62% Coolmax®
33% Poliamida
4% Elastodieno
1% Elastómero

Tallas:
M (36 a 39)
L (40 a 44)
XL (45 a 48)

Colores: Gris 05, Negro 99, Azul 69

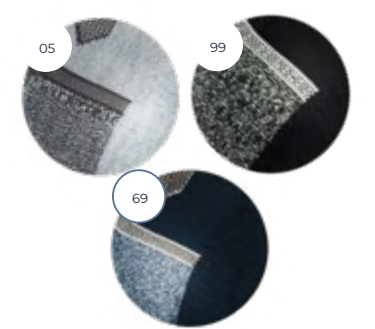



Con zonas de protección

Elástico especial en caña, empeine y tobillo

Mod. Etna
Código 1020

Sin costuras para evitar rozamientos



Mod. Vesubio
Código 1021



El calcetín de lana Vesubio es la versión larga, hasta la rodilla del Etna.

CALCETÍN Campo Lana

Características:

Especialmente indicado cuando se precisa abrigo para entornos con **temperaturas bajas** y actividades que se desarrollen en el exterior.

-Fabricado en Acrílico/Lana.

-Elástico especial en caña, empeine y tobillo para adaptación a distintas botas de montaña o trekking.

Recomendable para llevar con botas de piel hidrofugadas y/o con membranas transpirables e impermeables.

Composición:

58% Acrílico
25% Lana
14% Poliamida
2% Elastómero
1% Elastodieno

Tallas:

M (36 a 39)
L (40 a 44)
XL (45 a 48)

Colores: Verde 77



Multiusos
Standar

Elástico en la caña para mayor sujeción



Algodón con tratamiento Antibacteriano



CALCETÍN Equilibrio calidad y precio

Mod. Lanín
Código 1026

Características:

-El calcetín Lanín está fabricado en algodón con tratamiento antibacteriano.

-Es un artículo de uso standard.

-Es apto para todo tipo de calzado laboral.

Composición:

75% Algodón
23% Poliéster
2% Elastano

Tallas:

M (36 a 39)
L (40 a 44)
XL (45 a 48)

Colores: Negro 99

Se suministra en un pack de dos pares de calcetines.

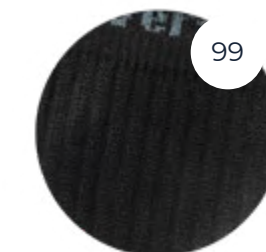

Sin costuras para evitar rozamientos

Algodón

Multiusos Standar

Con canalé en caña para una adecuada presión en la pierna, evitando la caída.

El calcetín Tacora es la versión del Colima con rizo en la planta del pie

Solo en el color 99

Todo Tiempo

Top Ventas

Mod. Colima
Código 1024

Mod. Tacora
Código 1025

Ergonomía

Sin costuras para evitar rozamientos

Con zonas de protección

Elástico en empeine y tobillo

Perfectos para el frío

LANA

Mod. Antuco
Código 1027

CALCETÍN

Adaptación a cualquier calzado

Características:

El calcetín Colima está fabricado en fibra natural de algodón peinado.

-Este calcetín es la versión "todo tiempo" del calcetín Tacora.

-Es un calcetín standar multiusos adecuado para todo tipo de trabajos.

-Con rizo interno en la planta del pie para una adecuada adaptación en la zona inferior del calzado.

Es apto para todo tipo de calzado laboral.

Composición:

80% Algodón
18% Poliamida
2% Elastodieno

Tallas:

M (36 a 39)
L (40 a 44)
XL (45 a 48)

Colores:

Blanco 00, Negro 99



CALCETÍN

doble capa con lana

Características:

El calcetín ANTUCO está fabricado en Lana.

-Su especial construcción en una capa exterior de poliamida y en su interior de lana lo convierten en un robusto y cálido calcetín.

-Especialmente indicado cuando se precisa abrigo para entornos con temperaturas bajas y actividades que se desarrollen en el exterior o interior.

Recomendable para llevar con botas de piel hidrofugadas y/o con membranas transpirables e impermeables.

Composición:

68% Lana
29% Poliamida
3% Elastómero

Tallas:

M (36 a 39)
L (40 a 44)
XL (45 a 48)

Colores:

Negro 99

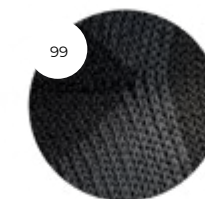



CALCETÍN con hilatura NanuTec

Mod. Kau
Código 1032

Características:

El calcetín técnico Kau está fabricado con la misma hilatura de NanuTec que nuestra camiseta térmica Nanuq.

- Alta capacidad de transpiración.
- Buena capacidad térmica.
- Cualidades de crear poco pilling.
- Alto poder antibacteriano.
- Tecnología NanuTec.

Composición:

82% Poliéster
13% Poliamida
5% Elastano

Tallas:
M (36 a 39)
L (40 a 44)
XL (45 a 48)

Colores:
Negro 99



*Pruebas realizadas por AITEX



CALCETÍN Semi-compresivo básico

Mod. Dana
Código 1035

Características:

El calcetín **semi-compresivo Dana** fabricado con una proporción de polipropileno **absorbe y elimina la humedad** y proporciona una sensación suave contra la piel. Con **canales de ventilación** y con un diseño especial del calcetín ya que no es simétrico y por tanto es **único para el pie izquierdo y para el derecho**.

Sin costuras y transpirable, hacen de él un producto ideado para el **calzado de protección** y para **uso general**.

Reforzado en puntera y planta del pie con poliamida, además **incorpora un especial diseño en talón y empeine**.

Colores: Negro 99

Composición:

20% Coolmax®
28% Polipropileno
29% Poliamida
15% Poliéster
8% Elastano

Tallas:
M (36 a 39)
L (40 a 44)
XL (45 a 48)

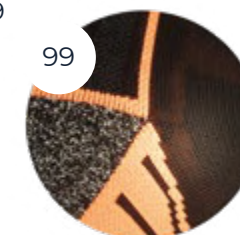



CALCETÍN

lana algodón todo tiempo

Mod. Saba
Código 1037

Características:

El calcetín Saba fabricado con una proporción de polipropileno absorbe y elimina la humedad y proporciona una sensación suave contra la piel, la mezcla con algodón y lana lo confieren para un producto ideal en actividades de campo y al aire libre.

La estructura del calcetín no es simétrica y por tanto es única para el pie izquierdo y para el derecho. Sin costuras. Reforzado en puntera y planta del pie con poliamida.

Composición:
47% Algodón
19% Lana
19% Polipropileno
18% Poliamida
2% Elastano

Tallas:
M (36 a 39)
L (40 a 44)
XL (45 a 48)

Colores: Verde 77



CALCETÍN

Tobillero

Mod. Pichincha
Código 1002



Características:

El calcetín Pichincha está fabricado en un suave algodón peinado.

-Tobillero fresco y elástico en la caña para una mayor sujeción.

-Ideal para todo uso y especialmente en temperaturas medias/altas y en especial donde se requiera un calzado deportivo o zueco.

Composición:
80% Algodón
18% Poliamida
2% Elastodieno

Tallas:
M (36 a 39)
L (40 a 44)
XL (45 a 48)

Colores:
Blanco 00, Negro 99

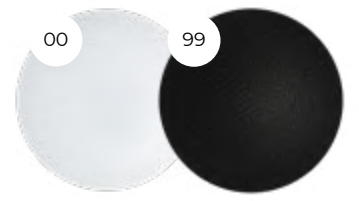



CALCETÍN básico de Thermolite®

Características:

El calcetín krakatoa está fabricado en un punto básico de **Thermolite®**.

-Es un **multiusos standar**, apto para distintos usos y entornos laborales de **temperaturas medias/bajas**.

Composición:

73% Thermolite®
21% Poliamida
4% Elastodieno
2% Elastómero

Tallas:

M (36 a 39)
L (40 a 44)
XL (45 a 48)

Colores: Negro 99

THERMOLITE®

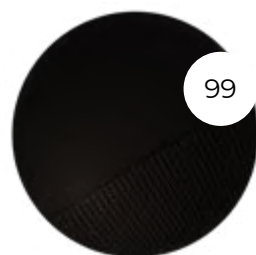

Mod. Krakatoa
Código 1009



CALCETÍN básico de Coolmax®

Características:

El calcetín Teide está fabricado en un punto básico de **Coolmax®**.

-Es un **multiusos standar**, apto para distintos usos y entornos laborales de **temperaturas medias/altas**.

-Elastico en el final de la caña.

Composición:

73% Coolmax®
21% Poliamida
4% Elastodieno
2% Elastómero

Tallas:

M (36 a 39)
L (40 a 44)
XL (45 a 48)

Colores: Negro 99

COOLMAX®

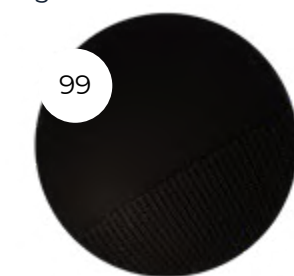

Mod. Teide
Código 1008



Multiusos Standar



Elástico al final de la caña para mayor sujeción

Cotton

CALCETÍN básico de algodón

Mod. Stromboli
Código 1010

Características:

El calcetín Stromboli fabricado en suave algodón, es un **multiusos standar**, apto para distintos usos y entornos laborales de **temperaturas medias/altas**.

Colores: Blanco 00, Negro 99



Composición:

73% Algodón
21% Poliamida
4% Elastodieno
2% Elastómero

Tallas:

M (36 a 39)
L (40 a 44)
XL (45 a 48)

Hilo de Escocia

Hilo de algodón de fibra larga, peinado y mercerizado.

Elástico en la caña para mayor sujeción

Frescor a la vez que calidez y comodidad.



CALCETÍN hilo de Escocia

Mod. Aracar
Código 1033

Características:

El modelo Aracar es un calcetín de **hilo de Escocia**.

-Está realizado con un hilo de **algodón de fibra larga, peinado y mercerizado**, que aporta una agradable sensación de **frescor**, a la vez que **calidez y comodidad**.

-Aconsejable para calzados de **servicios y de imagen corporativa**, y su utilización es óptima en temperaturas medias y altas.

Composición:
100% Algodón

Tallas:
S (38 a 39)
M (40 a 41)
L (42 a 43)
XL (44 a 45)

Colores: Negro 99

99



Cuando la fatiga aparece necesitas compresión

- ▶ Drena toxinas
- ▶ Reduce la fatiga
- ▶ Reduce los dolores
- ▶ Mejora la circulación sanguínea
- ▶ Ayuda al retorno de la sangre venosa



Drena Toxinas

Reduce los dolores musculares

CALCETÍN TERAPÉUTICO de Compresión

Características:

El Modelo Compressor es un calcetín de **compresión anti fatiga**.

-Éste aplica la presión necesaria sobre la pierna para activar la **circulación sanguínea** del trabajador, además tiene las cualidades de **reducir los dolores musculares y drena toxinas**.

Ayuda al **retorno de la sangre venosa** y mejora la circulación.

Tallas:

S (33 a 35)
M (36 a 39)
L (40 a 44)
XL (45 a 48)

Composición:

62% Poliéster
34% Poliamida
4% Elastómero

Colores: Blanco 00, Negro 99

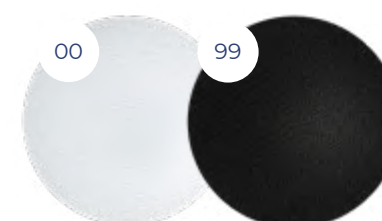

Mod. Compressor
Código 1029

.....



CALCETÍN

Anti-presión

Características:

El calcetín Orizaba está fabricado en un **algodón** con un punto especial que le confiere una **caña anti-presión**.

-No aprieta y se mantiene en su sitio. Es un **multiusos standar**, apto para distintos usos y entornos laborales de **temperaturas medias/altas**.

-El uso de algodón hace que sea especialmente indicado en aquellos casos en los que se requiere una **fibra natural libre de alergias**.

Composición:

80% Algodón
18% Poliamida
2% Elastodieno

Tallas:

M (36 a 39)
L (40 a 44)
XL (45 a 48)

Colores:

Blanco 00, Negro 99



Mod. Orizaba
Código 1022

CALCETÍN

básico de algodón

Características:

El calcetín Santorín está fabricado en un **suave algodón peinado**.

-Tobillero fresco y elástico en la caña para una **mayor sujeción**.

-Ideal para todo uso y especialmente en **temperaturas medias/altas** y donde se requiera un **calzado deportivo o zueco**.

Composición:

80% Algodón
16% Poliamida
1% Elastómero
3% Elastodieno

Tallas:

M (36 a 39)
L (40 a 44)
XL (45 a 48)

Colores: Blanco 00



Mod. Santorín
Código 1011

Chic Line "Bajo Pedido"



Línea de diseño exclusiva y con limitación de stock para analizar tendencias de mercado. Crisol de ideas e inspiración para nuevas prendas y proyectos corporativos.

ESCAPARATE

Chic Line "Bajo Pedido"

Americanas



Pantalones



Faldas y Vestidos



Americana
Cruzada
4 botones
Caballero



Mod. 10162026
Serie: 2026
Tejido: Style

Tallas:
De la 44 a 64

Composición:
55% Poliéster
40% Viscosa
5% Elastano
300 gr/m²

Colores:

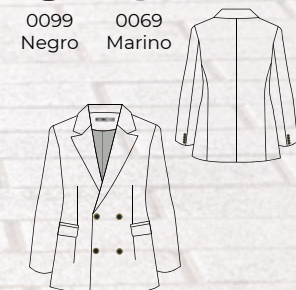

PANTALÓN Goma Elástica

Caballero



Mod. 1462026
Serie: 2026
Tejido: Style

Tallas:
De la 46 a 60

Composición:
55% Poliéster
40% Viscosa
5% Elastano
300 gr/m²

Colores:

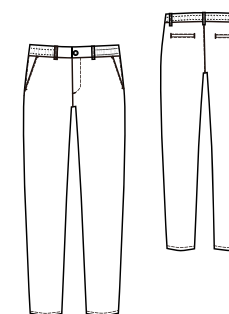

Americana

Cruzada

4 botones

Señora



Mod. 20722026

Serie: 2026

Tejido: Style

Tallas:

De la 36 a 50

Composición:

55% Poliéster
40% Viscosa
5% Elastano
300 gr/m²

Colores:

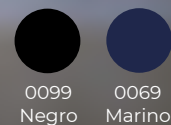

0099 Negro 0069 Marino



PANTALÓN

Palazzo

con dos bolsillos
delanteros
y uno trasero

Señora

Mod. S522026

Serie: 2026

Tejido: Style

Tallas:

De la 34 a 60

Composición:

55% Poliéster
40% Viscosa
5% Elastano
300 gr/m²

Colores:

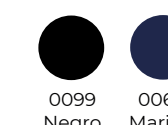

0099 Negro 0069 Marino



Americana

Solapa Invertida

Señora

Mod. 20732011

Serie: 2011

Tejido: Plácido

Tallas:

De la 36 a 50

Composición:

77% Poliéster
20% Viscosa
3% Elastómero
185 gr/m2

Colores:



0099 Negro
0069 Marino
0019 Gris Marengo



FALDA CRUZADA

Cierre con cremallera
en la parte trasera

Señora

Mod. 40602010

Serie: 2010

Tejido: Micropol

Tallas:

De la 34 a la 58

Composición:

100% Poliéster Microfibra
125 gr/m2

Colores:



0099 Negro
0069 Marino





FALDA PANTALÓN

Abertura en delantero y cinturón con doble piqueta

Señora

Mod. 41022025

Serie: 2025

Tejido: Boutique

Tallas:

De la 34 a 58

Composición:

95% Poliéster

5% Elastano

200 gr/m2

Colores:



0099 Negro

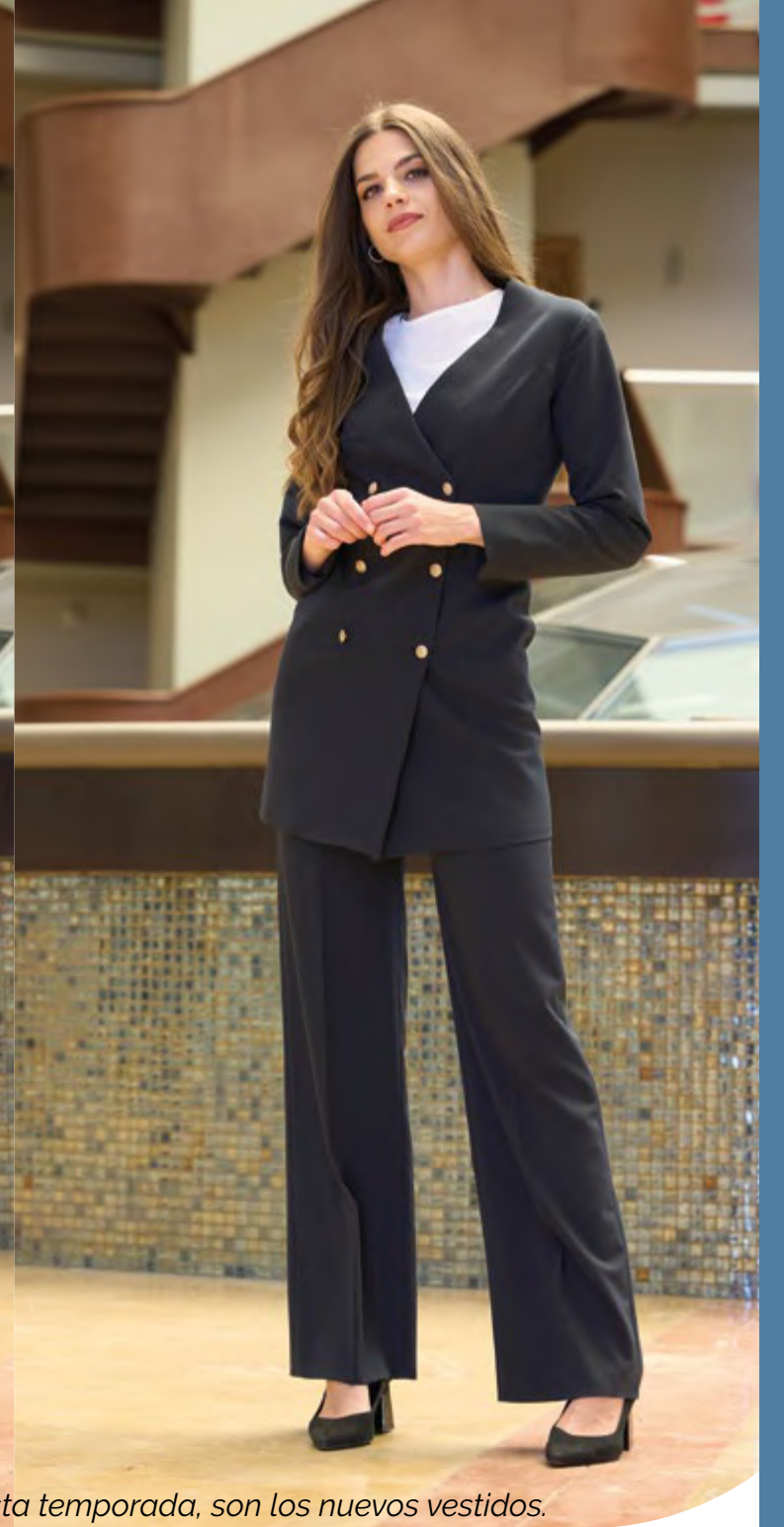
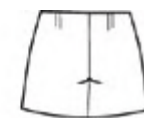

Las americanas de moda, esta temporada, son los nuevos vestidos.

VESTIDO AMERICANA

Cruzado Botones dorados

Señora



Mod. V0112011

Serie: 2011

Tejido: Plácido

Tallas:

De la 36 a 50

Composición:

77% Poliéster

20% Viscosa

3% Elastómero

185 gr/m2

Colores:



0099 Negro



0069 Marino





www.adversia.es

 926 26 01 71
926 26 00 53

 www.adversia.es

 C/ Alfareros 6-8,
Pol. Ind, Sepes, 13250
Daimiel (Ciudad Real)

